

High Quality Dental Instruments



✉ Email: [info@shahbazsurgicalworks.com](mailto:info@shahbazsurgicalworks.com)

☎ Whats App: +92 342 8510373

📍 Address: Street No. 5 Umer Pura Ugoki, Warirabad Road, Sialkot 51310, PAKISTAN



**EXTRACTING FORCEPS**



English Pattern



English Pattern



American Pattern



English Pattern,  
Anatomic Handle



Deep Grip Forceps





**EXTRACTING FORCEPS (English Pattern)**  
**Pinze estrazione**



001-000  
 1 Fig 1  
 Upper Centrals  
 and Canines



001-0002  
 Fig 2  
 Upper Laterals  
 and Canines



001-000  
 3 Fig 4  
 Lower Incisors  
 and Canines



001-000  
 4 Fig 7  
 Upper Premolars



001-000  
 5 Fig 8  
 Lower Premolars



001-0006  
 Fig 13  
 Lower Premolars



001-0007  
 Fig 17  
 Upper Molars,  
 Right



001-0008  
 Fig 18  
 Upper Molars,  
 Left



001-0009  
 Fig. 21  
 Lower Molar



001-0010  
 Fig 22  
 Lower Molar





**EXTRACTING FORCEPS (English Pattern)**  
**Pinze estrazione**



001-0011  
**# 18A**  
 upper molars



001-0012  
**# 19**  
 upper third molars



001-0013  
**# 20**  
 lower third molar



001-0014  
**# 24**  
 lower molar, right



001-0015  
**# 29**  
 upper roots



001-0016  
**# 30**  
 Upper Roots



001-0017  
**# 33**  
 lower roots



001-0018  
**# 33A**  
 Lower Roots



001-0019  
**# 33M**  
 Lower roots  
 with long beak



001-0020  
**# 46L**



001-0021  
**# 51**  
 Upper Roots



001-0022  
**# 51A**  
 Upper Roots



**EXTRACTING FORCEPS (English Pattern)**  
**Pinze estrazione**

**WISDOM EXTRACTING FORCEPS**



**001-0023**  
**Routurier**  
 (# 22 ½ L)  
 lower molars and  
 wisdoms, left



**001-0024**  
**Routurier**  
 (# 22 ½ R)  
 lower molars and  
 wisdoms, right



**001-0025**  
**Routurier**  
 (# 33 ½ L)  
 lower molar and  
 wisdom roots, left



**001-0026**  
**Routurier**  
 (# 33 ½ R)  
 lower molar and  
 wisdom roots, right



**001-0027**  
**Fig. 186L**  
 lower molars



**001-0028**  
**Fig. 186R**  
 lower molars



**001-0029**  
**# 51AL**



**001-0030**  
**# 67**  
 Upper Thnd Molars



**001-0031**  
**# 67A**  
 Upper Thnd Molars



**001-0032**  
**# 79**  
 Lower Third Molars



**EXTRACTING FORCEPS (English Pattern)**  
**Pinze estrazione**



001-0033  
 # 73  
 Lower Molars

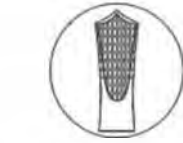

001-0034  
 # 73 A  
 lower molars



001-0035  
 # 73 S



001-0036  
 # 74  
 Lower Roots



001-0037  
 # 74N  
 Lower Roots



001-0038  
 # 75  
 Lower Premolars



001-0039  
 # 86A  
 Lower Molars



001-0040  
 # 86B  
 lower molars



001-0041  
 # 86C  
 lower molars



001-0042  
 # 87  
 Lower Molars



001-0043  
 # 89  
 Upper Molars,  
 Right



001-0044  
 # 90  
 Upper Molars,  
 Left



**EXTRACTING FORCEPS (English Pattern)**  
**Pinze estrazione**

A-TRAUMATIC EXTRACTION  
 Improved tapered beaks for complete root contact. Cross serrations.  
 Deep Gripe Extracting Forceps



- No Fracture
- No Tissue Damage
- Extraction With Easy



Thin Tip

001-0045  
 # 34

Upper incisors and  
 premolars  
 deep-gripping



Wide Tip

001-0046  
 # 34A

Upper centrals / cains  
 deep-gripping



Thin Tip

001-0047  
 Fig. 35

upper permolars  
 deep-gripping



Wide Tip

001-0048  
 # 35A

Upper incisors and  
 premolars  
 deep-gripping



Thin Tip

001-0049  
 # 36

Lower premolars  
 deep-gripping



Wide Tip

001-0050  
 # 36A

Lower premolars  
 deep-gripping



001-0051  
 # 336

lower permolars  
 deep-gripping



001-0052  
 F-7C

lower molar



001-0053  
 # 9

Apex Forceps Lower Universal  
 Deep Root Pick



001-0054  
 # 79N

Lower third molars  
 deep-gripping



001-0055  
 # 79

Lower Thrid Molars



**EXTRACTING FORCEPS (English Pattern)**  
 Pinze estrazione

**DEEP GRIP FORCEPS**



001-0056  
 # 146  
 Apex Forceps Lower Root  
 Deep Root Pick



001-0057  
 # 153  
 Apex Forceps Upper Root  
 Deep Root Pick



001-0058  
 # 149  
 Apex Forceps Upper Root  
 Deep Root Pick



001-0059  
 Fig. 44



001-0060  
 Fig. 44Z



001-0061  
 Fig. 45Z



001-0062  
 # 46XL  
 Apex Forceps Lower Root  
 Deep Root Pick



001-0063  
 # 67  
 Upper Third Molars



001-0064  
 # 67A  
 Upper Third Molars



001-0065  
 # 67N  
 Lower third molars  
 deep-gripping



001-0066  
 # 331  
 upper roots  
 deep-gripping





**EXTRACTING FORCEPS (English Pattern)**  
 Pinze estrazione



Fig. 1  
 upper  
 laterals  
 and canines



[www.detarcoodmedical.com](http://www.detarcoodmedical.com)

001-0067 Set of 10 Pieces

- Fig. 1
- Fig. 7
- Fig. 13
- Fig. 17
- Fig. 18
- Fig. 22
- Fig. 51A
- Fig. 67
- Fig. 74N
- Fig. 79

Fig. 7  
 upper  
 premolars



Fig. 13  
 lower  
 premolars



Fig. 17  
 upper  
 molars,  
 right



Fig. 18  
 upper  
 molars,  
 left



Fig. 22  
 lower  
 roots



Fig. 51A  
 upper roots



Fig. 67  
 upper third  
 molars



Fig. 74N  
 lower  
 molar



Fig. 79  
 lower third  
 molars





**EXTRACTING FORCEPS (English Pattern)**  
 Pinze estrazione

**Pediatric Tooth Extracting Forceps Set**



001-0068  
 English Pattern Klein #51S  
 Pedodontic Upper root



001-0069  
 English Pattern Klein #137  
 Pedodontic, Upper Incisors Spring handle  
 Baby Tooth Extraction Forceps



001-0070  
 English Pattern Klein #5  
 Pedodontic Lower Incisors.



001-0071  
 English Pattern Klein #139  
 Pedodontic Upper Premolars



001-0072  
 English Pattern Klein #7  
 Pedodontic Lower Roots,



001-0073  
 English Pattern Klein #3  
 Pedodontic Upper Molars Universal

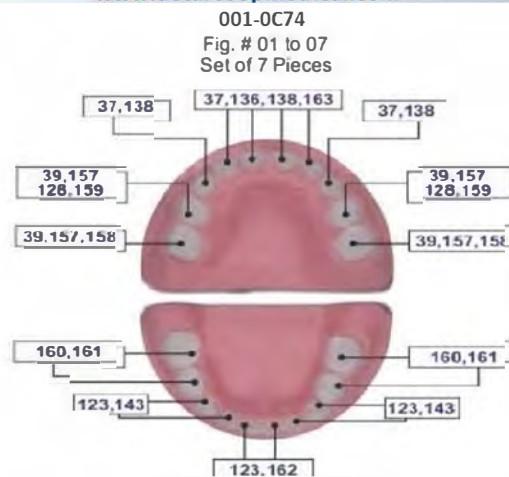

001-0074  
 English Pattern Klein #6  
 Pedodontic Lower Molars, Spring Handle



**EXTRACTING FORCEPS (English Pattern)**  
 Pinze estrazione



001-0075  
 # 1STD  
 Winter  
 upper centrals and canines



001-0076  
 Fig. 1  
 upper incisors  
 and roots



001-0077  
 Cryer  
 Fig. 150



**EXTRACTING FORCEPS (American Pattern)**  
**Pinze Estrazione (Forma Americana)**



001-0079  
 Fig. 62  
 incisors, premolars,  
 deciduous teeth



001-0080  
 # 10S  
 upper roots



001-0081  
 # 17  
 lower molars



001-0082  
 Harris  
 Fig. 18R



001-0083  
 Harris  
 Fig. 18L

001-0078  
 Fig. 150A  
 Cryer  
 upper incisors, premolars, roots



**EXTRACTING FORCEPS (English Pattern)**  
 Pinze estrazione



001-0075  
 # 1STD  
 Winter  
 upper centrals and canines



001-0076  
 Fig. 1  
 upper incisors  
 and roots



001-0077  
 Cryer  
 Fig. 150



**EXTRACTING FORCEPS (American Pattern)**  
**Pinze Estrazione (Forma Americana)**



001-0088  
 Fig. 24  
 upper molars



001-0089  
 # 210S  
 upper third molars



001-0090  
 # 210H  
 upper third molars



001-0091  
 # 286  
 Upper Roots,  
 Premolars, Incisors



001-0092  
 # 99C  
 Kells  
 upper incisors,  
 canines, premolars



001-0093  
 # 222  
 lower third molars



001-0094  
 # 286  
 Lower Molar



**EXTRACTING FORCEPS (English Pattern)**  
**Pinze estrazione**



001-0095  
 Nevius  
 Fig. 88L  
 upper molars, left



001-0096  
 Fig. 65  
 upper incisors  
 and roots



001-0097  
 Parmly Fig. 32A  
 upper premolars  
 and roots



001-0098  
 Parmly Fig. 32  
 upper premolars  
 and molars



**EXTRACTING FORCEPS (American Pattern)**  
**Pinze Estrazione (Forma Americana)**

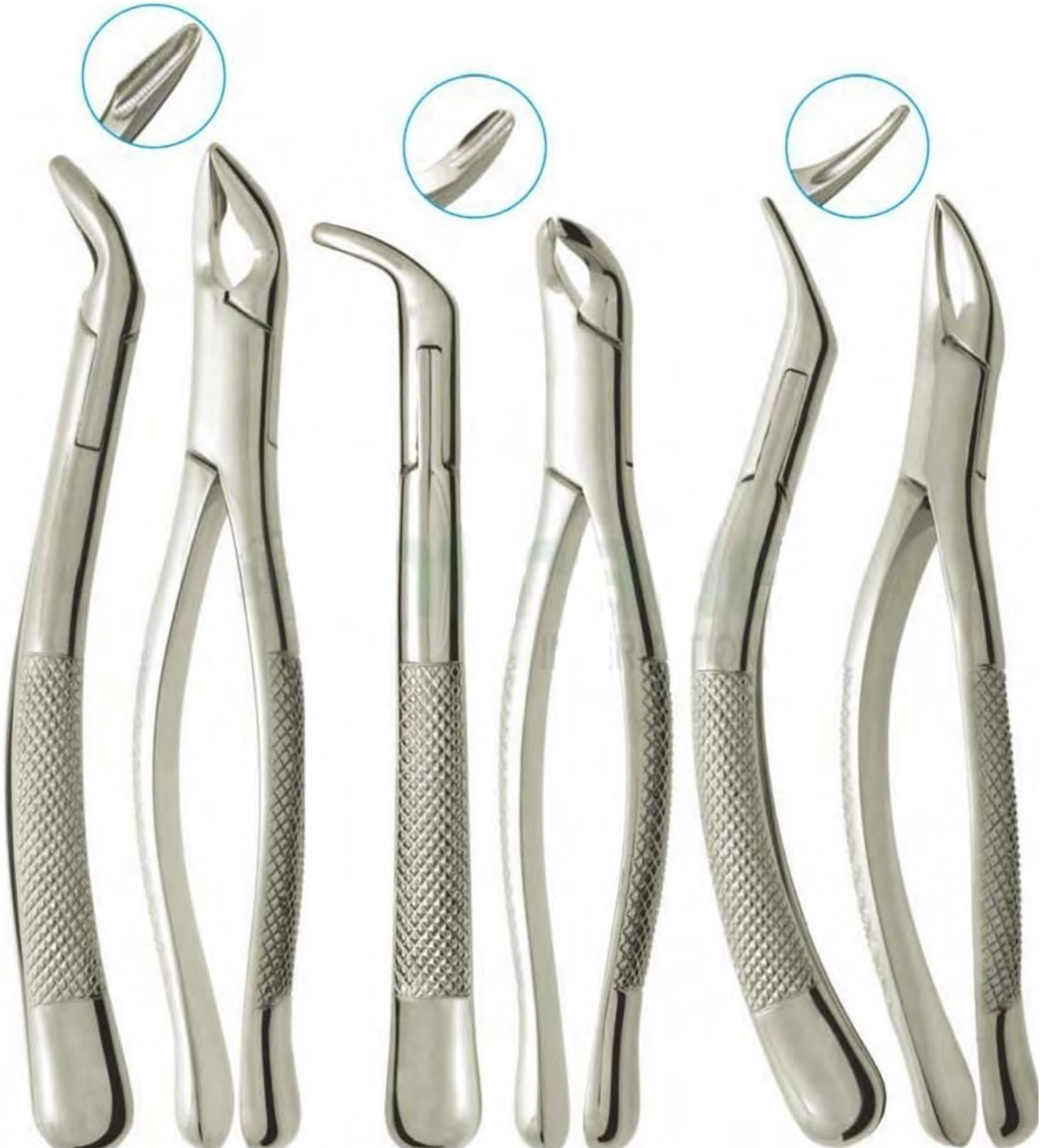

001-0099  
 COHEN  
 universal

001-0100  
 Fig 203  
 lower incisors  
 and roots

001-0101  
 Tomes Fig 69  
 upper and lower  
 roots





**EXTRACTING FORCEPS (English Pattern)**  
**Pinze estrazione**



001-0102  
 Fig. 23  
 lower molars



001-0103  
 Fig. 16  
 lower molars



001-0104  
 Physic Fig. 5  
 lower third molars



001-0105  
 Harris Fig. 15  
 lower molars



001-0106  
 Fig. 103



**EXTRACTING FORCEPS (American Pattern)**  
**Pinze Estrazione (Forma Americana)**



001-0107  
 Hull  
 Fig. 101  
 Deciduous teeth



001-0108  
 Cryer  
 Fig. 150S  
 upper teeth,  
 for children



001-0109  
 Fig. 150 AS



**EXTRACTING FORCEPS (English Pattern)**  
 Pinze estrazione



001-0110  
 Cryer  
 Fig 151  
 lower teeth,  
 for children

001-0111  
 Fig. 151 S  
 lower incisors,  
 premolars, roots

001-0112  
 Fig. 151 AS



**EXTRACTING FORCEPS (American Pattern)**  
**Pinze Estrazione (Forma Americana)**



001-0113  
 # 16S  
 lower molars for children



001-0114  
 # 17S  
 lower molars



001-0115  
 # 23 S  
 Lower molars



001-0116  
 # 27  
 lower molars



001-0117  
 # 18LS  
 upper molars left



001-0118  
 # 18RS  
 upper molars right



001-0119  
 # 85 Tomas  
 lower canines, premolars and molars



001-0120  
 # 85A Tomas  
 lower canines, premolars and molars



001-0121  
 # 69S  
 upper and lower roots

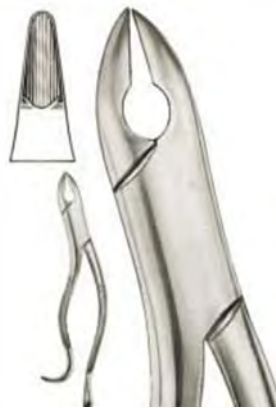

001-0122  
 # 99A Kells  
 upper incisors, canines, premolars



001-0123  
 # 217  
 lower molars



**EXTRACTING FORCEPS (English Pattern)**  
 Pinze estrazione



001-0124  
**#10 SK**  
 Upper Molars Sup



001-0125  
**#17 SK Universal**  
 Lower Molars



001-0126  
**#23 SK Universal**  
 Upper Molars



001-0127  
**#69 SK Tomas**  
 upper and lower roots



001-0128  
**#99 SK**  
 upper incisors,  
 canines, premolars



001-0129  
**#150 SK**  
 upper incisors,  
 premolars, roots



001-0130  
**#151 SK**  
 lower incisors,  
 premolars, roots



001-0131  
**#222 SK**  
 lower third molars



**EXTRACTING FORCEPS (American Pattern)**  
**Pinze Estrazione (Forma Americana)**



001-0132  
 Fig. 1  
 Upper Anterior

001-0133  
 Lower Molar  
 Fig 23 Cow Horn



001-0134  
 Fig 74  
 Lower Anterior



001-0135  
 Fig 88L  
 Upper Molar Left



001-0136  
 Fig 88R  
 Upper Molar Right



001-0137  
 Fig 74  
 Lower Anterior



001-0138  
 Fig 106  
 Lower Incisors



001-0139  
 Fig. 174  
 Extra Narrow  
 Lower Anterior  
 Apical Retention  
 Forceps



001-0140  
 Fig. 859  
 Lower Molars  
 Roots





**EXTRACTING FORCEPS (English Pattern)**  
**Pinze estrazione**



001-0145  
 Blumenthal  
 15cm



001-0141  
 Blumenthal  
 15cm



001-0142  
 Blumenthal  
 15cm



001-0143  
 Friedman  
 14cm



001-0144  
 Friedman  
 14.5cm



001-0146  
 Micro-Friedman  
 14cm



001-0147  
 Micro-Friedman  
 15cm



001-0148  
 Micro-Friedman  
 16cm



001-0149  
 Kleinert-Kutz  
 18.5cm



001-0150  
 Beyer  
 18.5cm



001-0151  
 Mead 1A  
 18.5cm



001-0152  
 Luer  
 18.5cm



**DENTAL SYRINGES**  
 Siringhe Dentali



002-0001  
 Parojet Intraligamental Syringe 1.8ml



002-0002  
 Parojet Intraligamental Syringe 1.8ml



002-0003  
 Parojet Intraligamental Syringe 1.8ml



002-0004  
 Parojet Intraligamental Syringe 1.8ml



002-0005  
 Intaligamental Anaesthesia Syringe 1.8ml



002-0006  
 Aspirating Syringes 1.8ml



002-0007  
 002-0008  
 Aspirating Syringes 1.8ml  
 Aspirating Syringes 2.2ml



002-0009  
 Folding Syringe, Ring Hsndle 1.8ml



002-0010  
 Folding Syringe, Ring Hsndle 1.8ml





**DENTAL SYRINGES**  
**Siringhe Dentali**



002-0011  
 Aspirating Syringes 1.8ml



002-0016  
 Infiltration Aspirating Syringe 1.8ml



002-0012  
 Aspirating Syringes 1.8ml



002-0017  
 Infiltration Aspirating Syringe 1.8ml

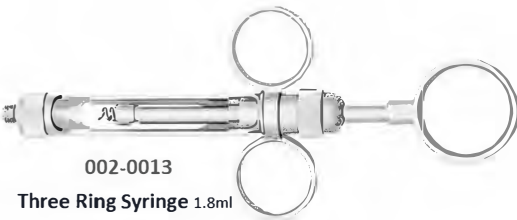

002-0013  
 Three Ring Syringe 1.8ml



002-0018  
 Aspirating Syringes 1.8ml



002-0014  
 Folding Syringe 1.8ml



002-0019  
 Infiltration Aspirating Syringe 1.8ml

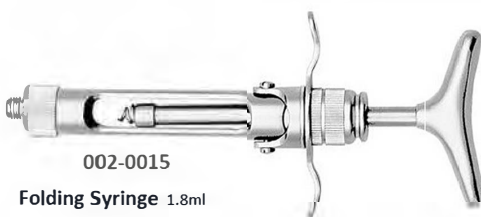

002-0015  
 Folding Syringe 1.8ml



002-0020  
 Infiltration Aspirating Syringe 1.8ml



**DENTAL SYRINGES**  
 Siringhe Dentali



002-0021  
 Intraligamental Anaesthesia Syringe 1.8ml



002-0022  
 PAROJET INTRALIGAMENTAL SYRINGE 1.8ml



002-0023  
 Aspirating Syringes 1.8ml



002-0024  
 Aspirating Syringes 1.8ml  
 Aspirating Syringes 2.2ml



002-0025  
 Aspirating Syringes 1.8ml



002-0026  
 Aspirating Syringes 1.8ml



002-0027  
 Three Ring Syringe 1.8ml



002-0028  
 Three Ring Syringe 1.8ml



002-0029  
 Folding Syringe 1.8ml



002-0030  
 Folding Syringe 1.8ml



**DENTAL SYRINGES**  
**Siringhe Dentali**

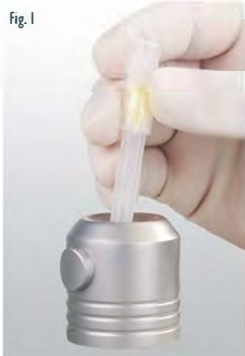

002-0031



002-0032



002-0034



002-0035



002-0036



002-0037  
 Needle Re-Capper



002-0038



002-0039  
 Needle Re-Capper Ultima



002-0040



**HANDLES FOR ROOT ELEVATORS POINT  
A, B, C, D**

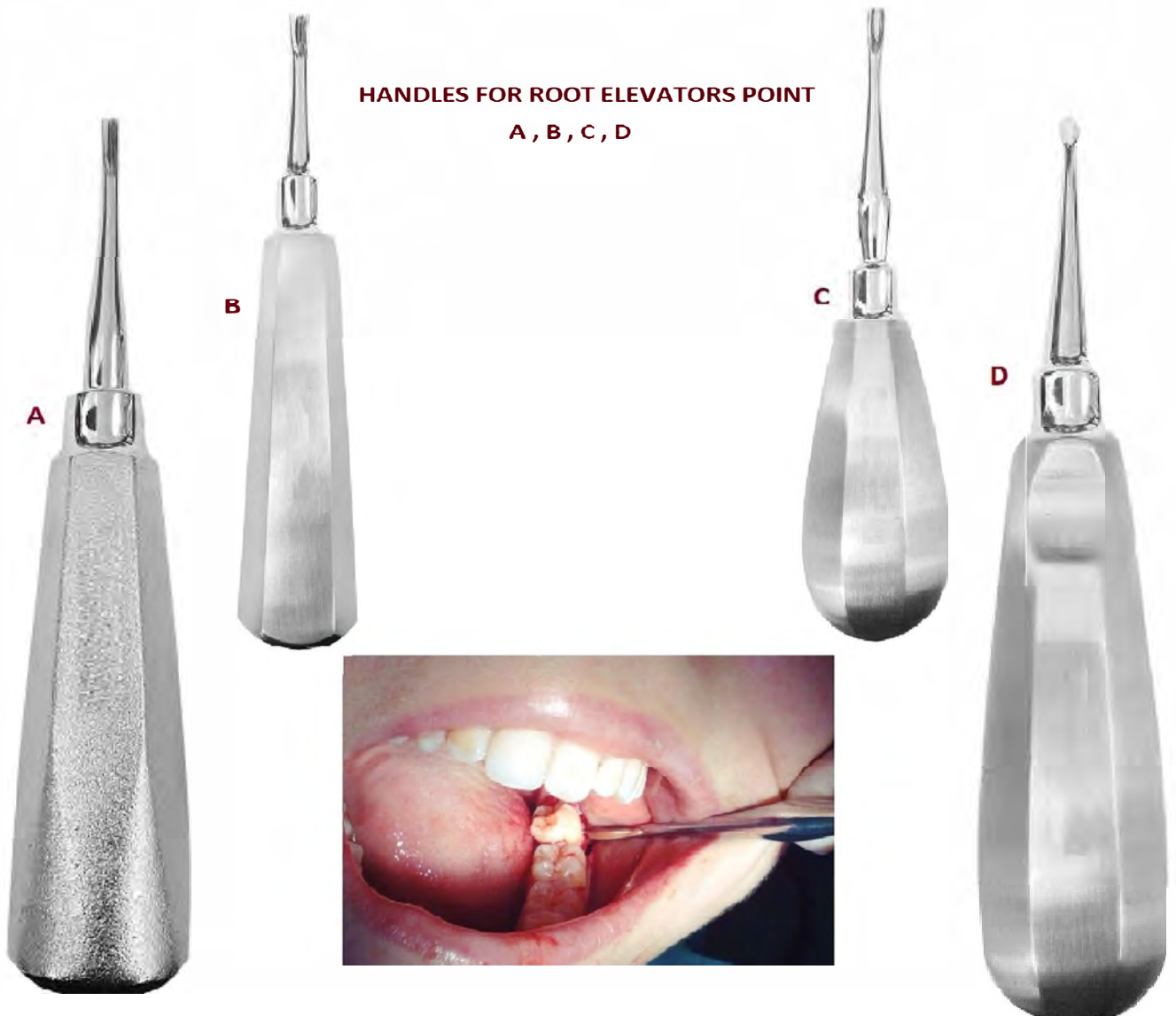



**HANDLES ROOT ELEVATORS**  
 Leve Per Radici

**Apexo Root Elevators**

|   |   |   |   |  |   |   |
|---|---|---|---|--|---|---|
|  |  |  |  |  |  |  |
|   | 003-0001<br>Apexo<br>2.5x9mm<br>Straight  | 003-0002<br>Apexo<br>2.7x9mm<br>Straight  | 003-0003<br>Apexo<br>3.0x9mm<br>Straight  | 003-0004<br>Apexo<br>2.5x9mm<br>Curved   | 003-0005<br>Apexo<br>3.0x9mm<br>Curved  | 003-0006<br>Seldin<br>3.0x14mm<br>Straight  |





Apexo

**Luxator Root Elevators**

|  |  |  |  |  |  |  |
|--|--|--|--|--|--|--|
|  |  |  |  |  |  |  |
|  | 003-0007<br>Luxator<br>3mm<br>straight   | 003-0008<br>Luxator<br>3mm<br>curved   | 003-0009<br>Luxator<br>4mm<br>straight   | 003-0010<br>Luxator<br>4mm<br>curved   | 003-0011<br>Luxator<br>5mm<br>straight   | 003-0012<br>Luxator<br>5mm<br>curved   |





Luxator

**Bein Root Elevators**

|   |   |   |   |
|---|---|---|---|
|  |  |  |  |
|   | 003-0013<br>Bein 2mm  | 003-0014<br>Bein 3mm  | 003-0015<br>Bein 4mm  |

Bein

**Seldin Root Elevators**

|   |   |   |   |
|---|---|---|---|
|  |  |  |  |
|   | 003-0016<br>Flohr 1   | 003-0017<br>Seldin 34S  | 003-0018<br>Seldin 34   |

Seldin



**HANDLES ROOT ELEVATORS**  
**Leve Per Radici**

**Apexo Root Elevators**



Apexo

|  |  |  |  |  |  |
|--|--|--|--|--|--|
|  |  |  |  |  |  |
| 003-0019<br>Apexo<br>2.5x9mm<br>Straight | 003-0020<br>Apexo<br>2.7x9mm<br>Straight | 003-0021<br>Apexo<br>3.0x9mm<br>Straight | 003-0022<br>Apexo<br>2.5x9mm<br>Curved | 003-0023<br>Apexo<br>3.0x9mm<br>Curved | 003-0024<br>Seldin<br>3.0x14mm<br>Straight |

**Luxator Root Elevators**



Luxator

|  |                                      |  |                                      |  |                                      |
|--|--------------------------------------|--|--------------------------------------|--|--------------------------------------|
|  |                                      |  |                                      |  |                                      |
| 003-0025<br>Luxator<br>3mm<br>straight | 003-0026<br>Luxator<br>3mm<br>curved | 003-0027<br>Luxator<br>4mm<br>straight | 003-0028<br>Luxator<br>4mm<br>curved | 003-0029<br>Luxator<br>5mm<br>straight | 003-0030<br>Luxator<br>5mm<br>curved |

**Bein Root Elevators**



Bein

|                      |                      |                      |
|----------------------|----------------------|----------------------|
|                      |                      |                      |
| 003-0031<br>Bein 2mm | 003-0032<br>Bein 3mm | 003-0033<br>Bein 4mm |

**Seldin Root Elevators**



Seldin

|                     |                        |                       |
|---------------------|------------------------|-----------------------|
|                     |                        |                       |
| 003-0034<br>Flohr 1 | 003-0035<br>Seldin 34S | 003-0036<br>Seldin 34 |



**HANDLES ROOT ELEVATORS**  
 Leve Per Radici

**Apical Root Elevators**

003-0037  
Fig. 1  
str.

003-0038  
Fig. 4  
Left

003-0039  
Fig. 5  
Right

**Apical Root Elevators**

003-0040  
Fig. 2  
str.

003-0041  
Fig. 3  
Left

003-0042  
Fig. 4  
Right

**Coupland Root Elevators**

003-0043  
Coupland No.1

003-0044  
Coupland No.2

003-0045  
Coupland No.3

**Seldin Root Elevators**

003-0046  
Seldin 4L  
(Left)

003-0047  
Seldin 4R  
(Right)

003-0048  
Seldin 1L  
(Left)

003-0049  
Seldin 1R  
(Right)

003-0050  
Seldin  
(Left)

003-0051  
Seldin  
(Right)



**HANDLES ROOT ELEVATORS**  
**Leve Per Radici**

**Apical Root Elevators**

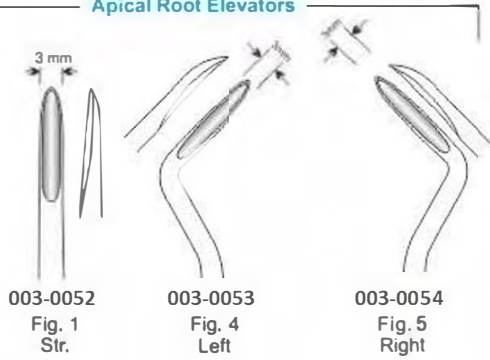
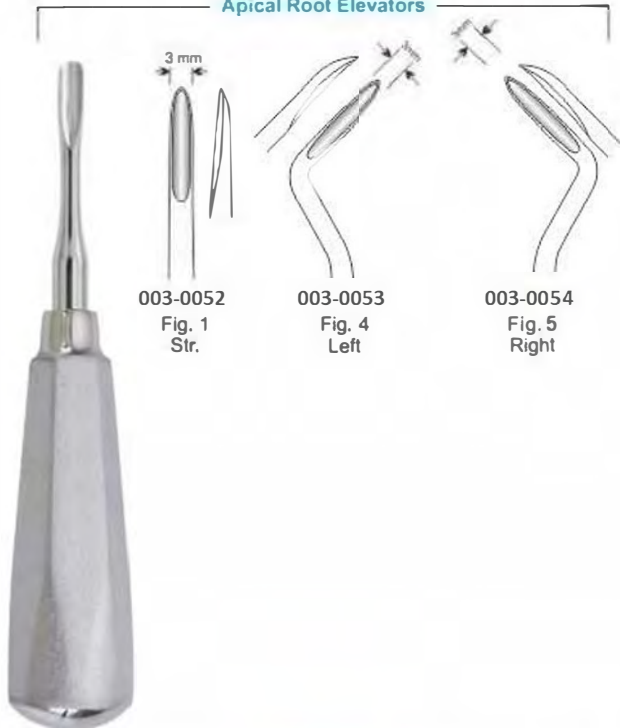

**Apical Root Elevators**

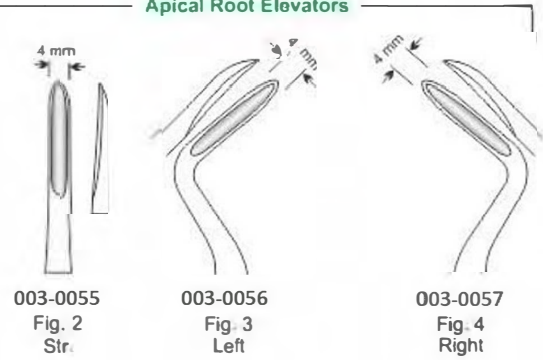
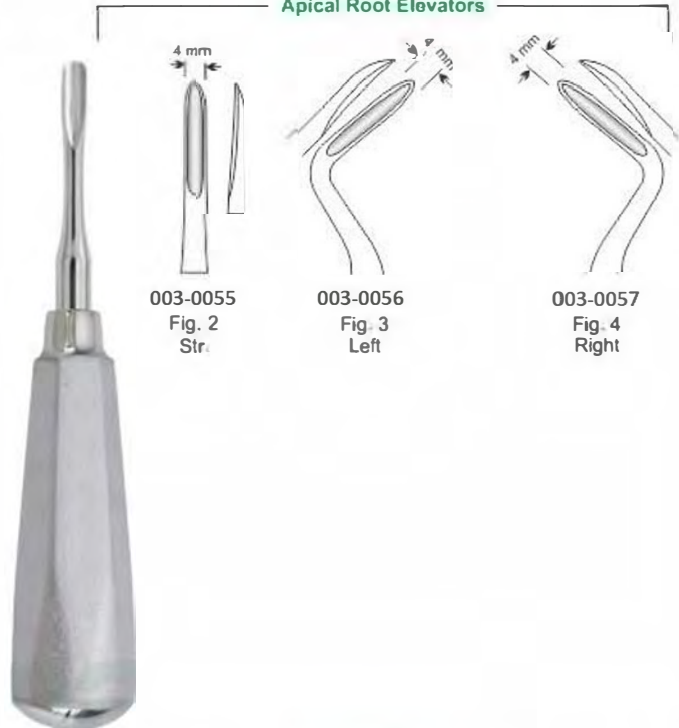

**Coupland  
 Root Elevators**

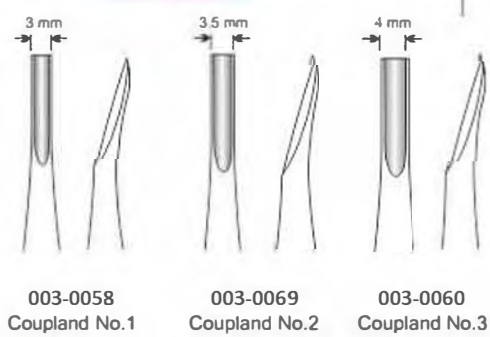
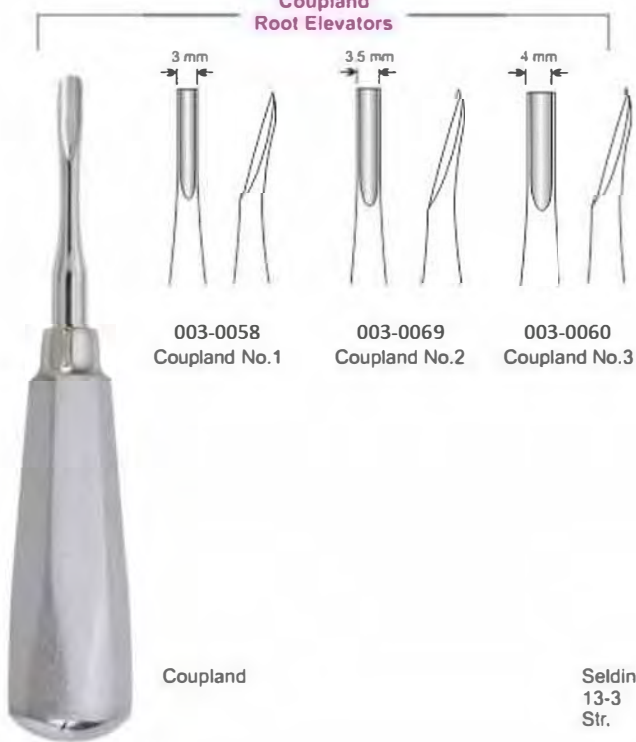

**Seldin  
 Root Elevators**

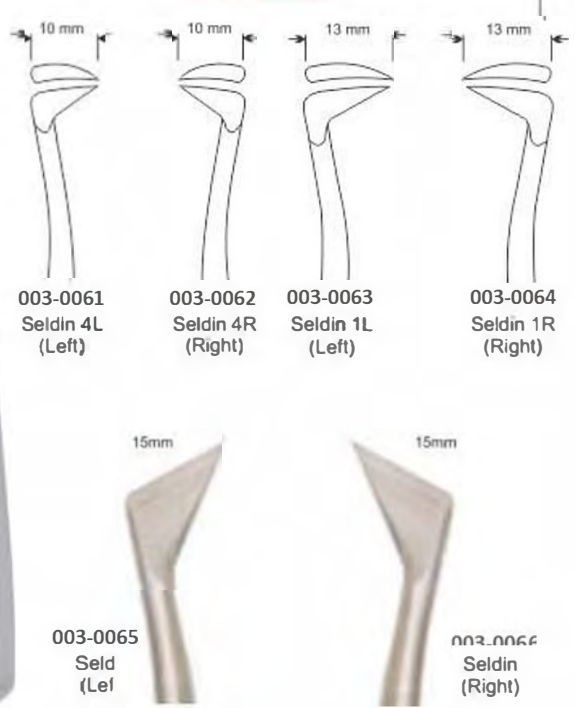
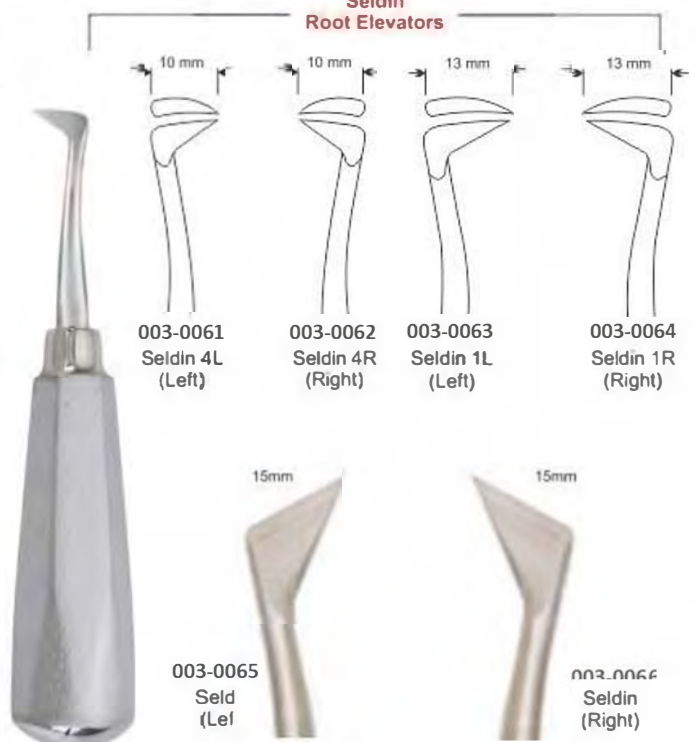





**HANDLES ROOT ELEVATORS**  
 Leve Per Radici

Apical Root Elevators

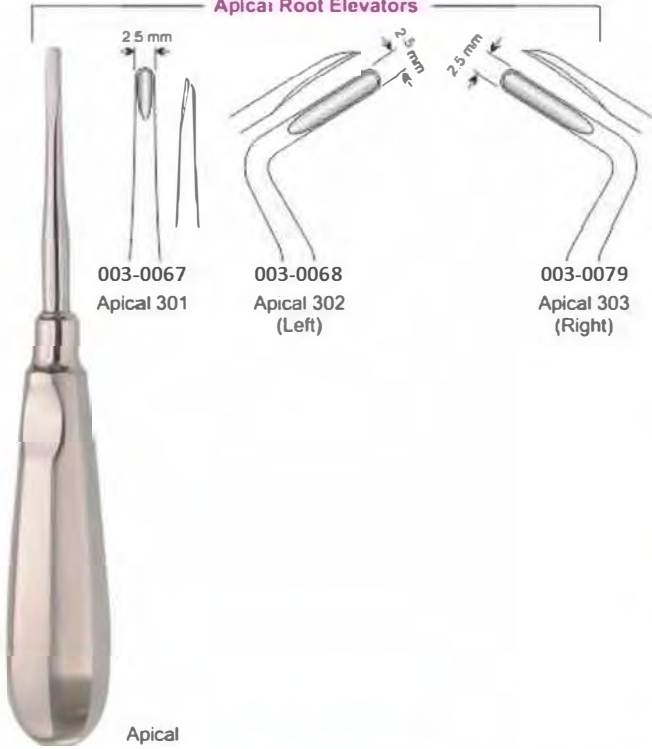

Apical Root Elevators

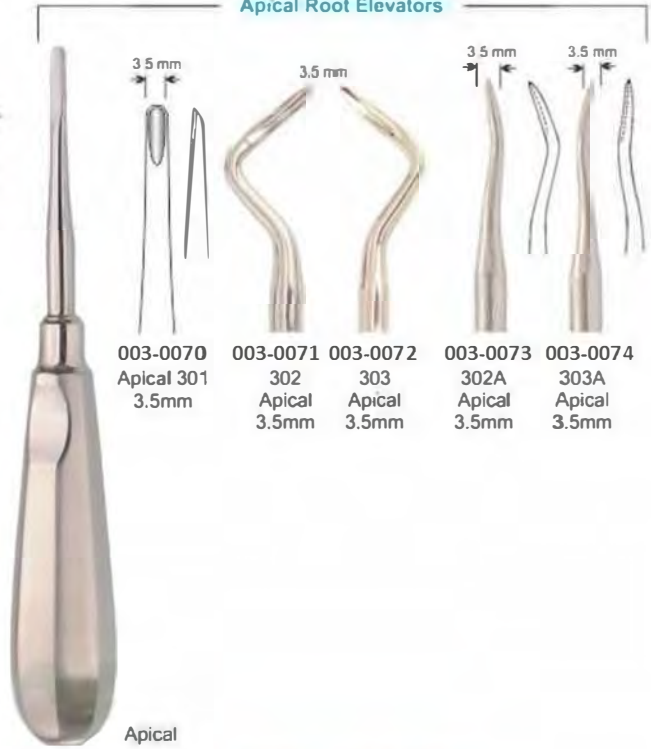

Apical Root Elevators



Laxutor Root Elevators

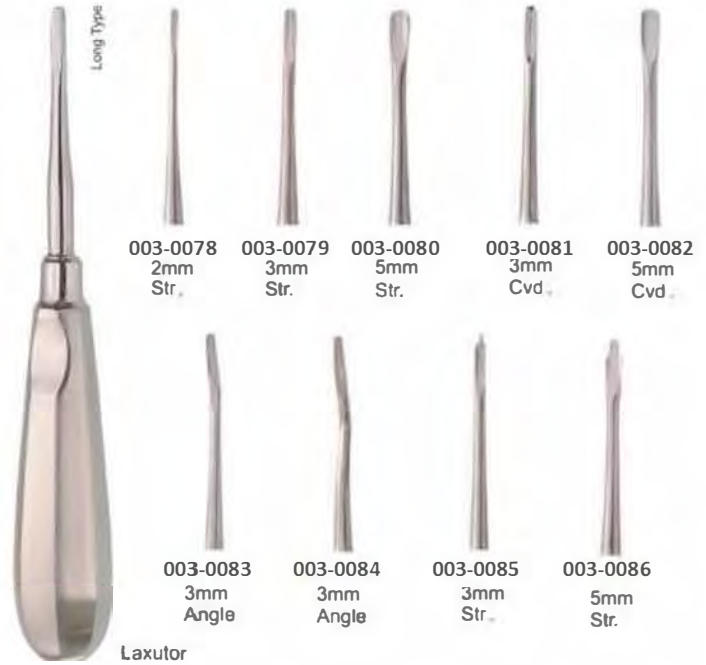



**HANDLES ROOT ELEVATORS**  
**Leve Per Radici**

**Lindo Levian Root Elevators**

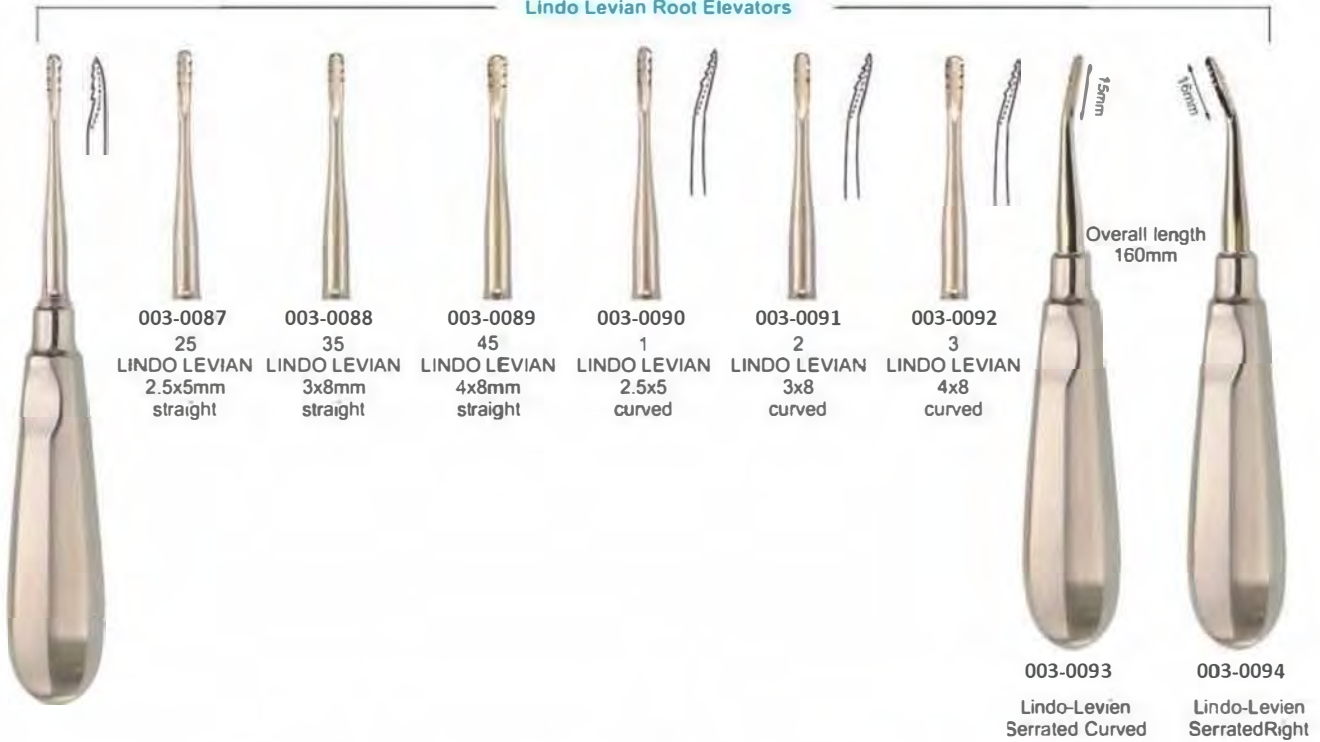

**Flohr Root Elevators**

**Heidbrink Root Elevators**

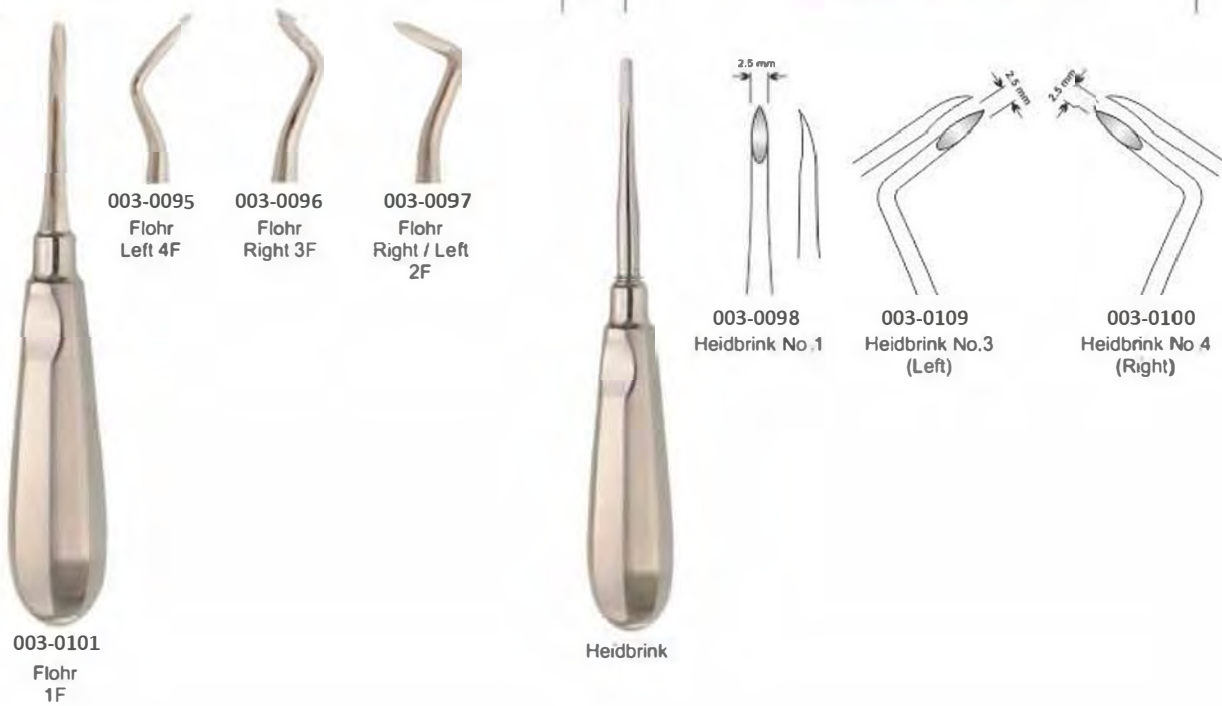



**HANDLES ROOT ELEVATORS**

Leve Per Radici

Friedmann Roots Elevator



003-0102 Friedmann 4F Str.  
 003-0103 Friedmann 5F Left  
 003-0104 Friedmann 6F Right

Heidbrink Roots Elevator



003-0105 Heidbrink Straight  
 003-0106 Heidbrink Left  
 003-0107 Heidbrink Right

Wisdom Roots Elevator



003-0108 Wisdom for 18 and 38  
 003-0109 Wisdom for 28 and 48

Bayonet Roots Elevator Set



003-0110 Left  
 003-0111 Right  
 003-0112 bayonet  
 003-0113 Curved  
 003-0114 Straight

Luxator Roots Elevator



003-0115 Luxator Straight  
 003-0116 Luxator Curved



**HANDLES ROOT ELEVATORS**  
**Leve Per Radici**

**Roots Elevator**

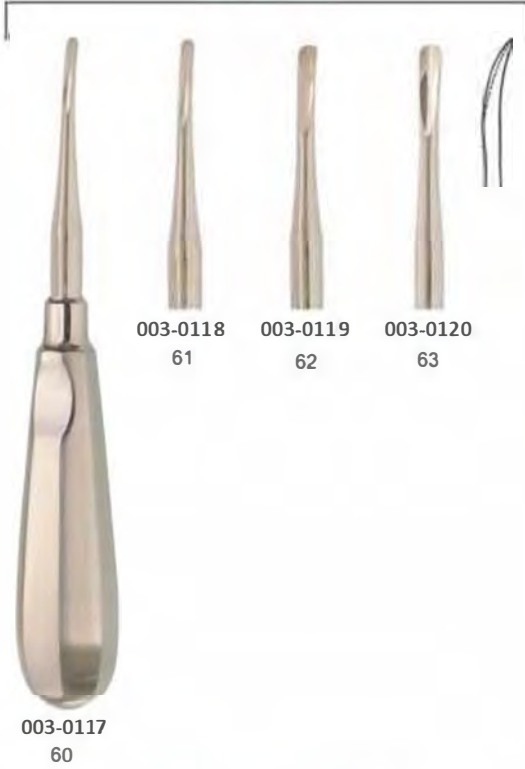

**Luxier Roots Elevator**



**Luxier Roots Elevator**

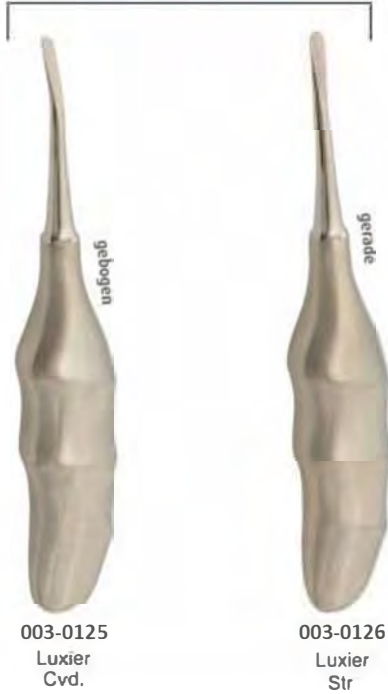

**Claw-Lift Roots Elevator**





**HANDLES ROOT ELEVATORS**  
 Leve Per Radici

**Hylin Roots Elevator**

2.3mm  
 20mm  
 4mm  
 19mm

003-0130 Hylin 3.5mm Str.  
 003-0131 Hylin 3.5mm Left  
 003-0132 Hylin 3.5mm Right

003-0129 Hylin Overall length 154mm  
 003-0133 Hylin 4.5mm Str.  
 003-0134 Hylin Overall length 153mm

**Cryer Roots Elevator**

003-0135 Cryer 77 Right/Left  
 003-0136 Cryer 27S Left  
 003-0137 Cryer 28S Right

**Kopp Roots Elevator**

003-0138 1 KOPP 3.6mm Upper Roots

003-039 2 KOPP 3.6mm Upper Roots  
 003-0140 3 KOPP 4.2mm Upper Roots  
 003-0141 4 KOPP 4.2mm Upper Roots

003-0143 2 KOPP 3.6mm Lower Roots  
 003-0144 3 KOPP 4.2mm Lower Roots  
 003-0145 4 KOPP 4.2mm Lower Root



**HANDLES ROOT ELEVATORS**  
**Leve Per Radici**

**Kopp Roots Elevator**



003-0146  
 Kopp  
 Right

003-0147  
 Kopp  
 Left

**Heber Roots Elevator**



003-0148  
 Heber  
 Bavonet

003-0149  
 Heber  
 Bayonet

**Bein Roots Elevator**



003-0150  
 Bein,  
 3mm

003-0151  
 Bein,  
 4mm

**Bein Roots Elevator**

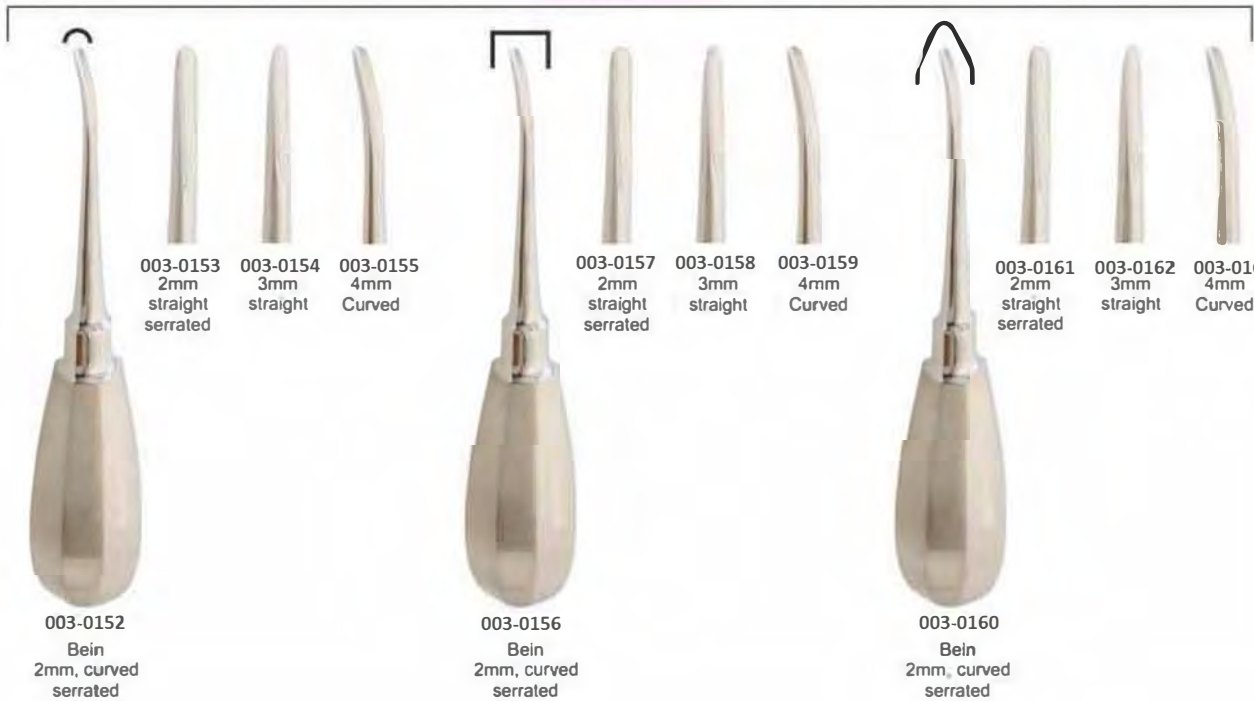

003-0152  
 Bein  
 2mm, curved  
 serrated

003-0156  
 Bein  
 2mm, curved  
 serrated

003-0160  
 Bein  
 2mm, curved  
 serrated

003-0153  
 2mm  
 straight  
 serrated

003-0154  
 3mm  
 straight

003-0155  
 4mm  
 Curved

003-0157  
 2mm  
 straight  
 serrated

003-0158  
 3mm  
 straight

003-0159  
 4mm  
 Curved

003-0161  
 2mm  
 straight  
 serrated

003-0162  
 3mm  
 straight

003-0163  
 4mm  
 Curved





**HANDLES ROOT ELEVATORS**  
 Leve Per Radici

**Seldin Roots Elevator**



**W. Barry Roots Elevator**



**Winter Roots Elevator**



**Pott Roots Elevator**

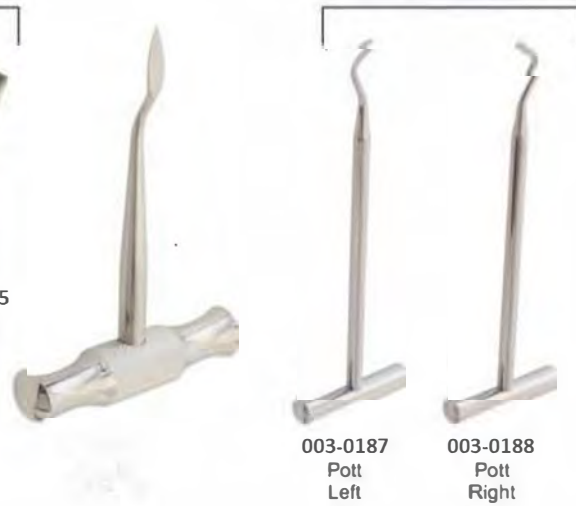



**HANDLES ROOT ELEVATORS**  
 Leve Per Radici

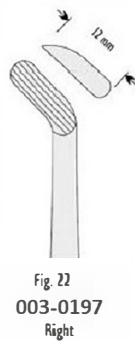
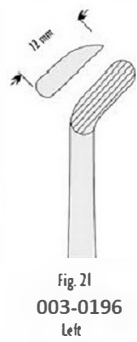
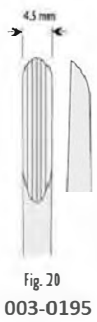
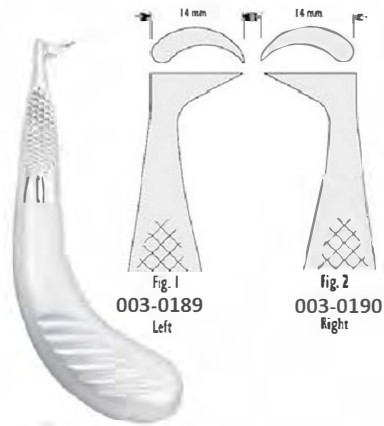

Root tip picks

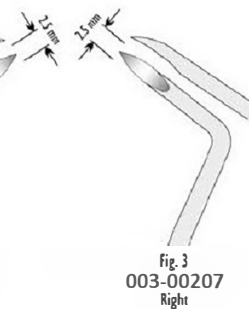
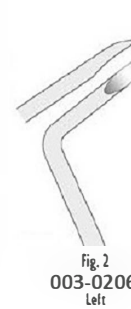
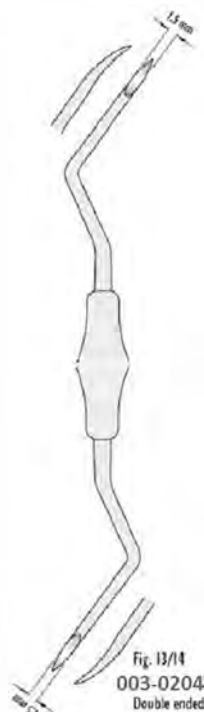
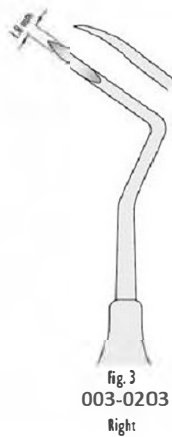
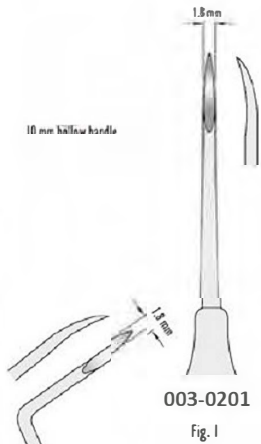





**LUXATOR ELEVATORS**  
 Luxator Elevators



003-0208  
 1S  
 (Straight 1mm)



003-0209  
 2S  
 (Straight 2mm)



003-0210  
 3S  
 (Straight 3mm)



003-0211  
 5S  
 (Straight 5mm)



003-0212  
 3C  
 (Curved 3mm)



003-0213  
 5C  
 (Curved 5mm)



003-0214  
 3CA  
 (Curved Angle 3mm)



003-0215  
 3IC  
 (Inverted Curved 3mm)



003-0216  
 DE 3  
 (Dual Edge 3mm / 1.5mm)



003-0217  
 DE 5  
 (Dual Edge 5mm / 3mm)



**PDL ELEVATORS**

**PDL ELEVATORS**  
**PDL Ascensore Periotome**



003-0218  
 PDL Elevators  
 Set of 7 Pcs



003-0219  
 PDL Elevators  
 Set of 7 Pcs



**PDL ELEVATORS**  
**PDL Ascensore Periotome**

**PDL ELEVATORS**



Delicate Arrow tip



4,0mm straight  
 4,0mm curved

Luxivators straight  
 atraumatic luxation of the tooth



2,5mm straight  
 3,5mm straight  
 4,5mm straight

Luxivators curved  
 atraumatic luxation of the tooth



2,5mm curved  
 3,5mm curved  
 4,5mm curved

003-0220  
 PDL Elevators  
 Set of 8 Pcs



**TWEEZERS**  
 Pinzette



005-0018



005-0019



005-0020



005-0021



005-0022



005-0023



005-0024



005-0025



005-0026  
 Crane Kaplan  
 15cm



005-0027  
 Crane Kaplan  
 15cm



005-0028  
 Hemingway  
 15cm



005-0029  
 Miller  
 15cm Str.



005-0030  
 Miller  
 15cm Cvd.



005-0031  
 Dressing  
 Tweezer  
 14.5cm



005-0032  
 College  
 Curved  
 Tip 15cm



005-0033  
 Maryam  
 Tweezers  
 15cm



005-0034  
 College  
 Tweezer  
 15cm



005-0035  
 Perry  
 Tweezer  
 12.5cm



005-0036  
 Self-locking  
 Tweezer  
 15cm



**TWEEZERS**  
 Pinzette



005-0001  
 Surgical  
 11.5cm



005-0002  
 London College  
 15cm



005-0003  
 Semken Taylor  
 Str.



005-0004  
 Semken Taylor  
 Cvd.



005-0005  
 Meriam  
 16cm



005-0006  
 Dressing  
 14cm



005-0007  
 Semken Taylor  
 1x2 Straight



005-0008  
 Semken Taylor  
 1x2 Curved



005-0009  
 Gilles  
 15cm 1x2



005-0010  
 14cm 1x2



005-0011  
 Perry  
 13cm



005-0012  
 Atraumatic  
 15cm Cvd



005-0013  
 Atraumatic  
 15cm Str.



005-0014  
 College with Lock  
 15cm Cvd.



005-0015  
 Gerald  
 17.5cm



005-0016  
 with lock  
 15cm



005-0017  
 Atraumatic  
 17.5cm



**TWEEZERS**  
 Pinzette



005-0018



005-0019



005-0020



005-0021



005-0022



005-0023



005-0024



005-0025



005-0026  
 Crane Kaplan  
 15cm



005-0027  
 Crane Kaplan  
 15cm



005-0028  
 Hemingway  
 15cm



005-0029  
 Miller  
 15cm Str.



005-0030  
 Miller  
 15cm Cvd.



005-0031  
 Dressing  
 Tweezer  
 14.5cm



005-0032  
 College  
 Curved  
 Tip 15cm



005-0033  
 Maryam  
 Tweezers  
 15cm



005-0034  
 College  
 Tweezer  
 15cm



005-0035  
 Perry  
 Tweezer  
 12.5cm



005-0036  
 Self-locking  
 Tweezer  
 15cm



**TWEEZERS**  
 Pinzette

**Dissecting and Tissue Forceps**



005-0037



Adson  
120 mm  
Titanium



1 x 2 th  
005-0038



DeBokey  
Atraumatic  
150 mm



005-0039



005-0040



005-0041



Adson  
120 mm



1 x 2 th  
005-0042



DeBokey  
Atraumatic  
160 mm



005-0043



005-0044



170 mm

005-0045



Adson-Micro



160 mm

005-0046



Adson-Micro

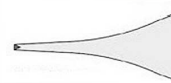

120 mm

005-0047



150 mm

005-0048



120 mm

005-0049



Adson



150 mm

005-0050



Adson



120 mm

005-0051

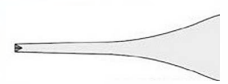

150 mm

005-0052



100 mm

005-0053



Iris



100 mm

005-0054



Iris



100 mm

005-0055



100 mm

005-0056



125 mm

005-0057



Semken



125 mm

005-0058



Semken



125 mm

005-0059



125 mm

005-0060



Gerald



175 mm

005-0061



175 mm

005-0062



Gerald

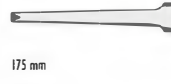

175 mm

005-0063



175 mm

005-0064



**TWEEZERS**  
 Pinzette



- 005-0065 130 mm / 5 1/4"
- 005-0066 150 mm / 6"
- 005-0067 180 mm / 7"
- 005-0068 200 mm / 8"
- 005-0069 255 mm / 10"
- 005-0070 305 mm / 12"

**Standard**  
 (English Pattern)



- 005-0071 130 mm / 5 1/4"
- 005-0072 150 mm / 6"
- 005-0073 180 mm / 7"
- 005-0074 200 mm / 8"

**TOE**  
 (English Pattern)



- 005-0075 130 mm / 5 1/4"
- 005-0076 150 mm / 6"
- 005-0077 180 mm / 7"
- 005-0078 200 mm / 8"

**Stille -Leeds**  
 (Swedish Pattern)



- Lane**
- 005-0079 140 mm / 5 1/2"
  - 005-0080 180 mm / 7"



- Bonney**
- 005-0081 180 mm / 7"



- Ramsey**
- 005-0082 180 mm / 7"



- Jean**
- 005-0083 145 mm / 5 3/4"
  - 005-0084 180 mm / 7"



- Maingot**
- 005-0085 280 mm / 11"





**EXPLOERS SINGLE ENDED**  
**Sonde Singole**

Single Ended Probe Solid Handle 4.5mm Length 150mm

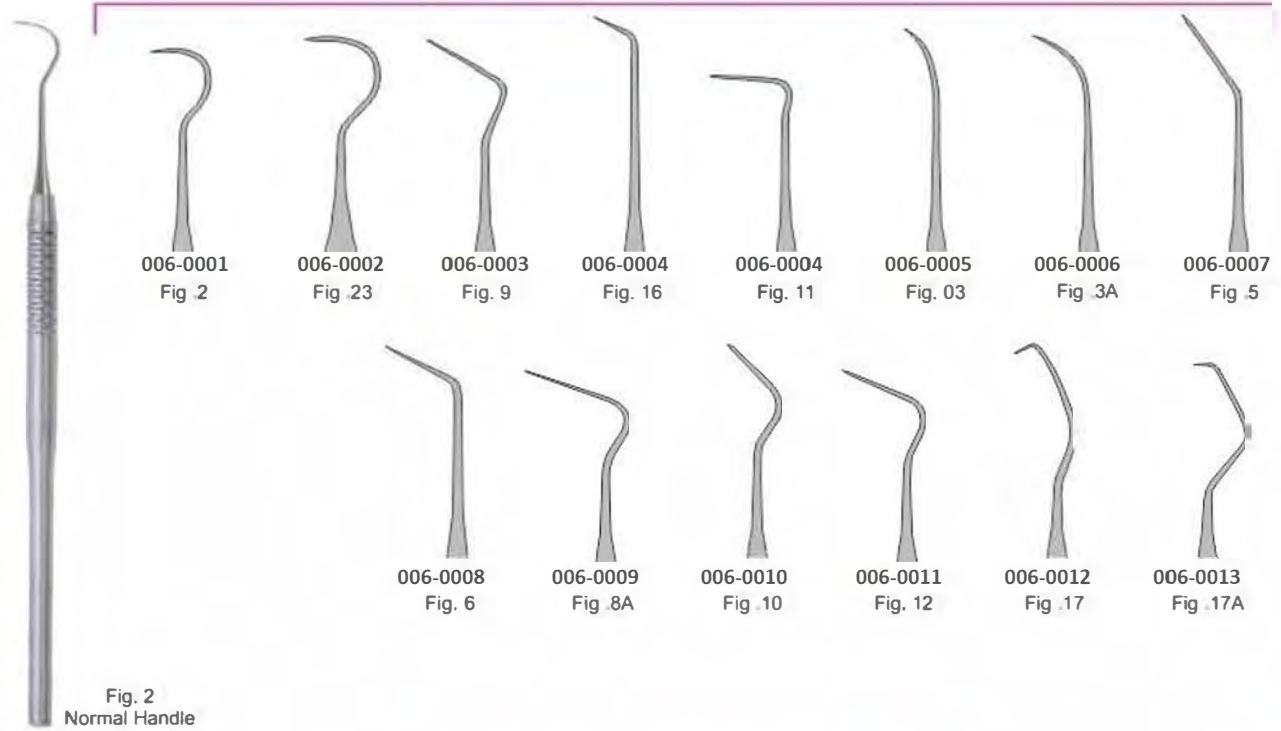

Single Ended Probe Hollow Handle 8.5mm Length 150mm

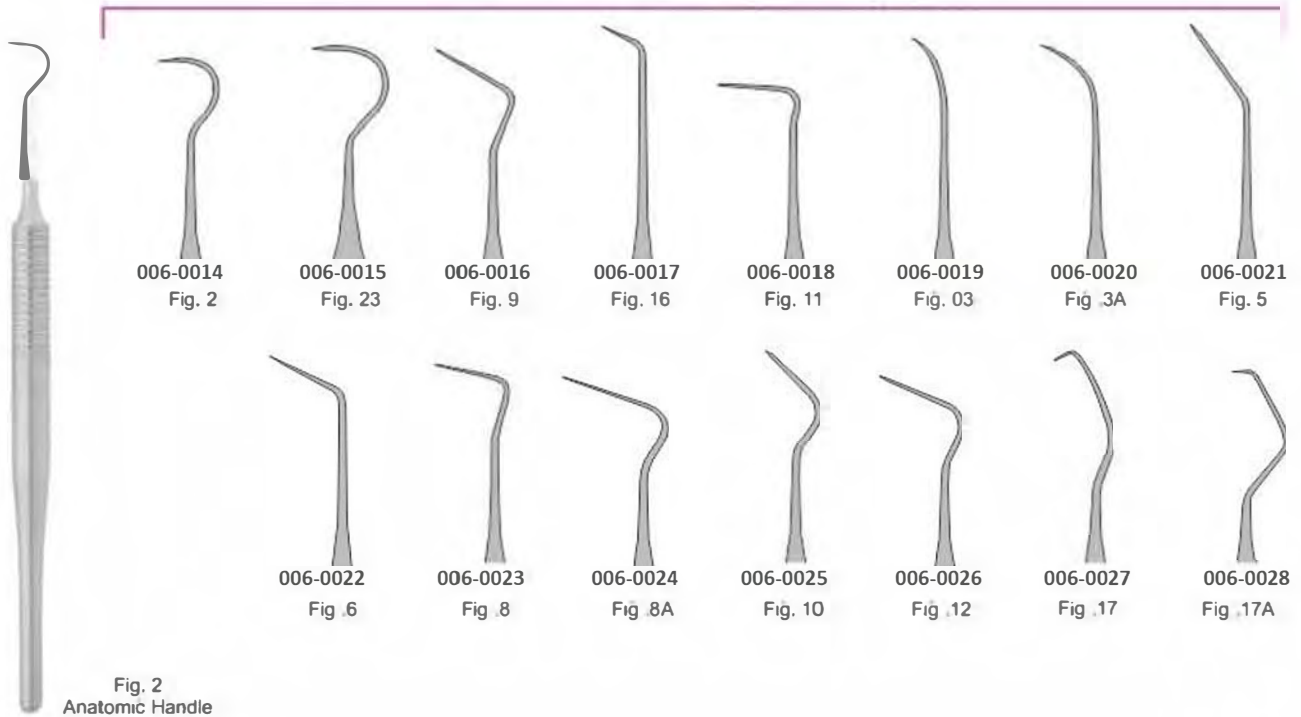



**EXPRO AND PROBES**  
**Expro E Sonde**

Probes Single End Solid Handle 6mm. length 150mm



006-0029 Fig. 6    006-0030 Fig. 8    006-0031 Fig. 9  
 006-0032 Fig. 16    006-0033 Fig. 23

Probes Single Ended 6mm. length 150mm

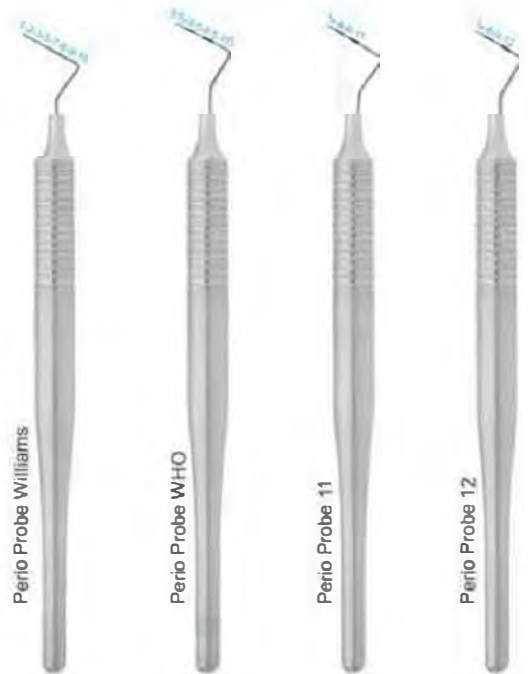

006-0034    006-0035    006-0036    006-0037

Examination kit Set of 3 Pieces



006-0038 Probe    006-0039 Mirror    006-0040 College Forcep 15cm

Examination Set of 4 Pieces



006-0040 A

Examination Set of 4 Pieces



006-0041 Exp.23/17-A    006-0042 Exavators    006-0043 Tweezers    006-0044 Mouth Mirror



## Our Scalers

Compare our scalers and curettes with the best in the industry and you will immediately recognize we are equal in every way but one... price. Note the deep precision knurling for better tactile feel. The same high-grade stainless steel tips, the same light weight (under 18 grams) for less hand fatigue, the same professional craftsmanship, and surpassing the highest industry standards. Of course, any manufacturer can make these claims, but we guarantee and certify ours.

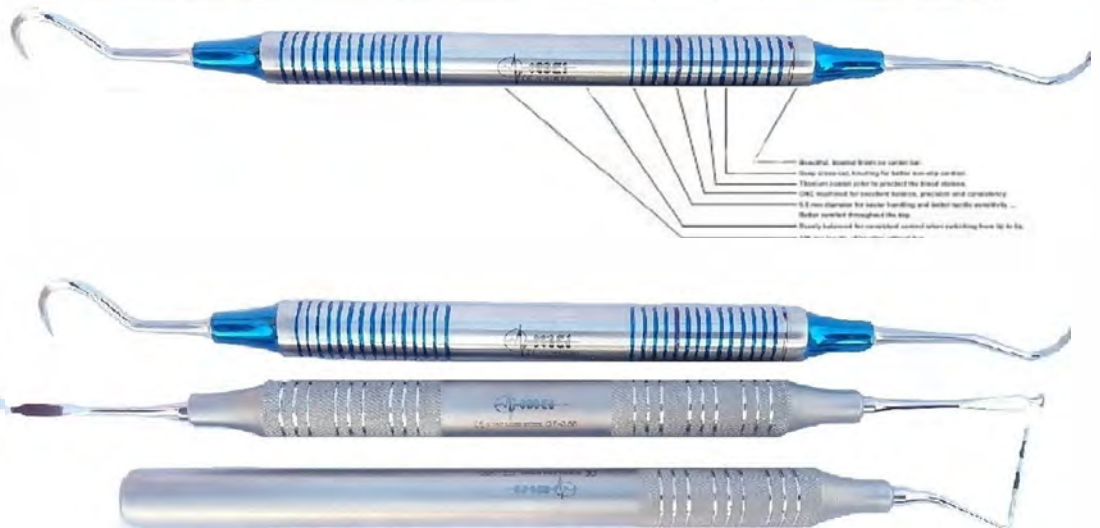

- High-polish mirror finish tips.
- Manufactured within the guidelines of the FDA quality assurance system for good manufacturing practices.
- Highest grade German stainless steel, razor sharp, durable tips. Rockwell hardened to 60 RHc.
- 27 of the most popular designs from graceys to McCalls to columbias, and many european patterns.
- All instruments are guaranteed against defects in material and workmanship.

- All instruments bear the ce mark, emblematic of the european community's highest standards.
- Customer satisfaction guarantee, too!
- Less than 20 grams ... Lightweight for less hand fatigue.
- Manufactured to the most exacting standards so the 50th instrument you buy is exactly like your first.
- You decide ... Why pay more for the same high-quality instruments?



**EXPRO AND PROBES**  
 Expro E Sonde

**EXPLORERS INSTRUMENTS**  
 SOLID HANDLE 6MM, LENGTH 170MM

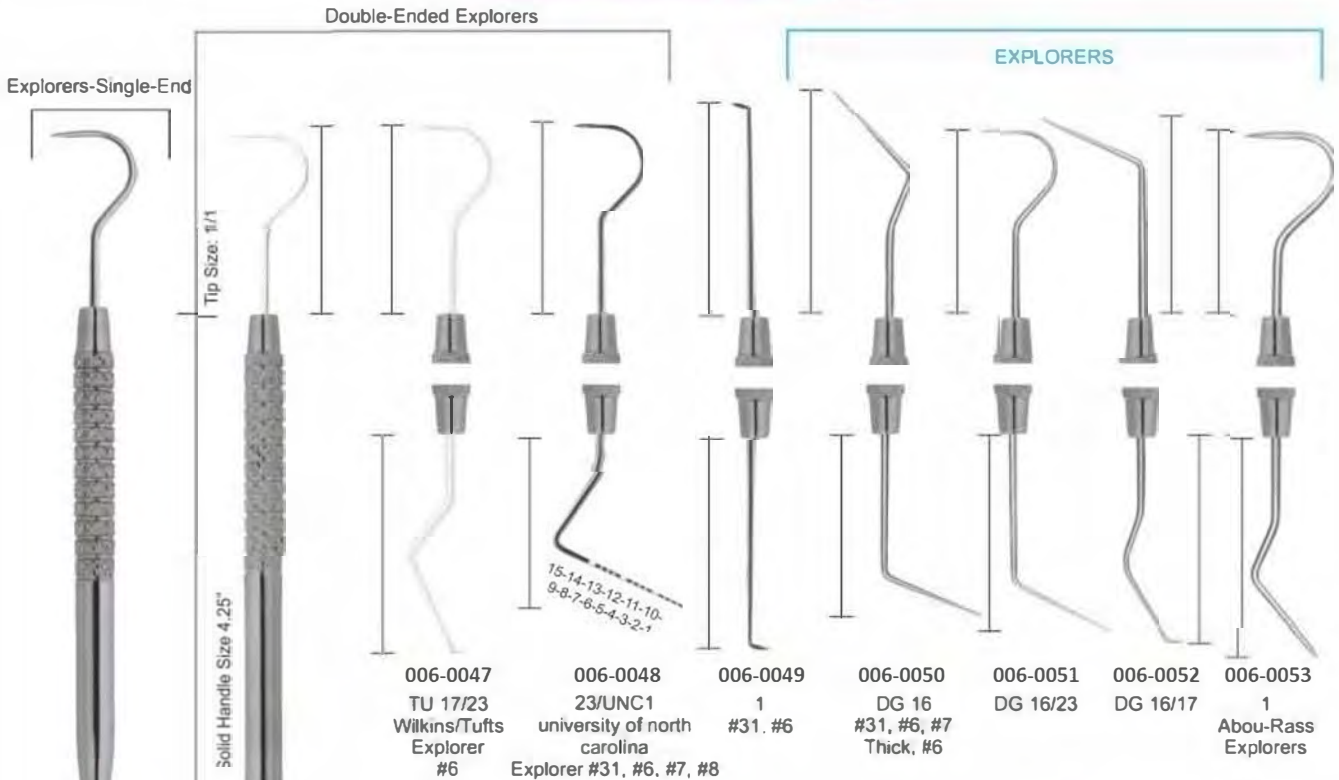

006-0045  
 23  
 Shepherd's Hook Explorer #30, #6, #7, #8

006-0046  
 #5, #6 Explorer

Probes Double Ended 6mm, length 170mm

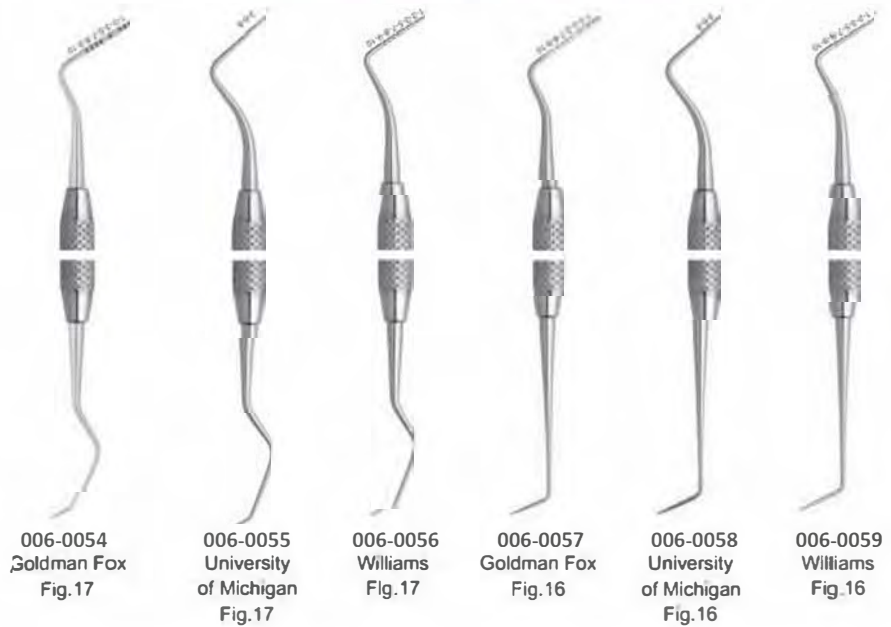



**PROBES SINGLE ENDED**  
**Sonde Millimetriche Singole**

Pointed Probes Single Ended Handle 6mm ,length 150mm



Pointed Probes Double Ended Handle 6mm ,length 170mm





**PERIODONTAL INSTRUMENTS**  
 Struments Pour La parodontologie

**PERIODONTAL SET OF 10 PIECES SOLID HANDLE 6MM LENGTH 170MM**

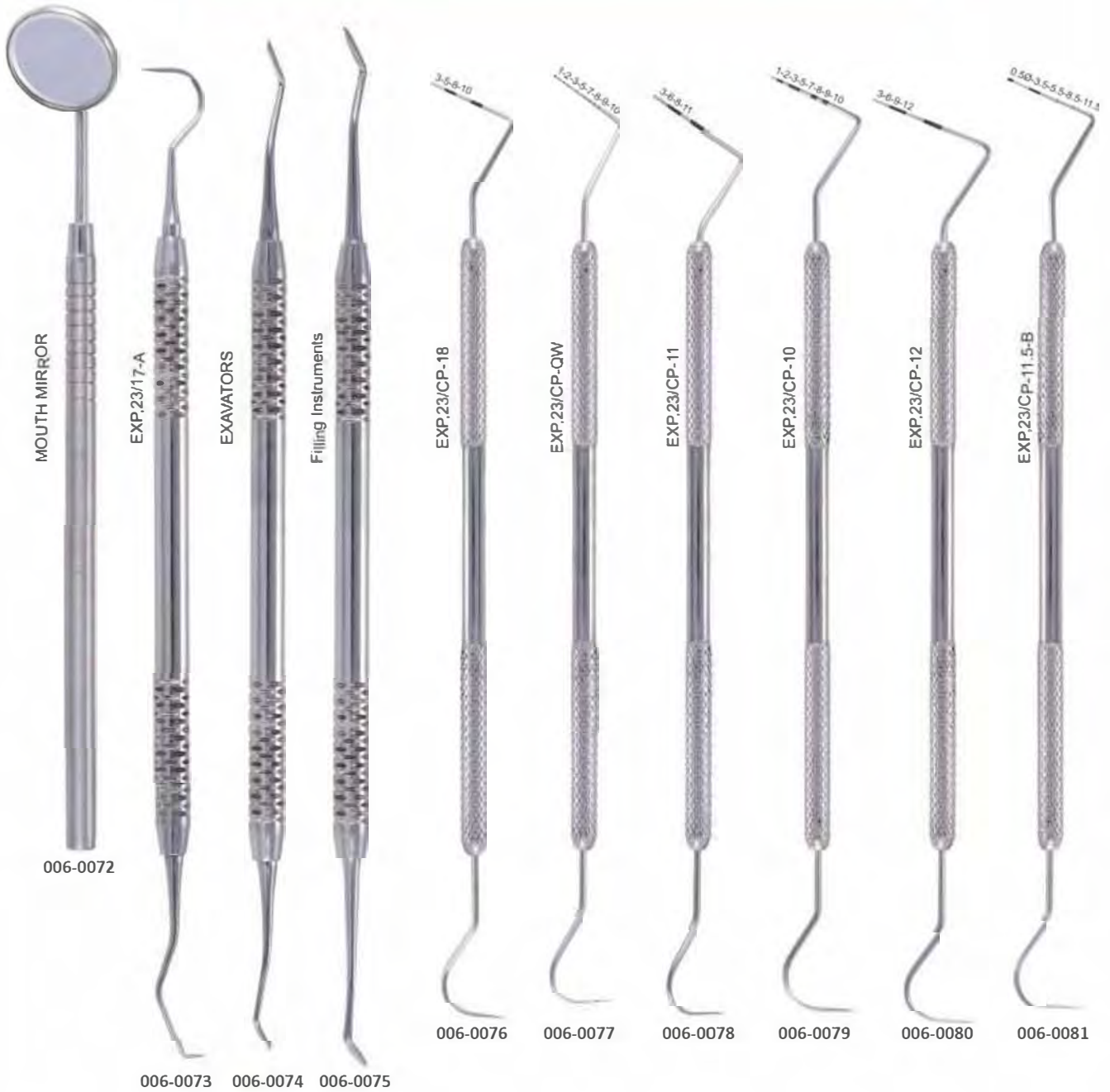



**PROBES DOUBLE ENDED**  
**Sonde Millimetriche**

WILLIAM PROBE SET DOUBLE ENDED WITH HOLLOW HANDLE 9.5MM, LENGTH 170MM  
 CERAMIC COATED HANDLE

Proper care must be given during cleaning, sharpening and sterilization to preserve design and integrity and to prolong usefulness. Do not expose instruments to sterilization temperatures above 350 F/177 C or to higher than recommended chemical concentrations.

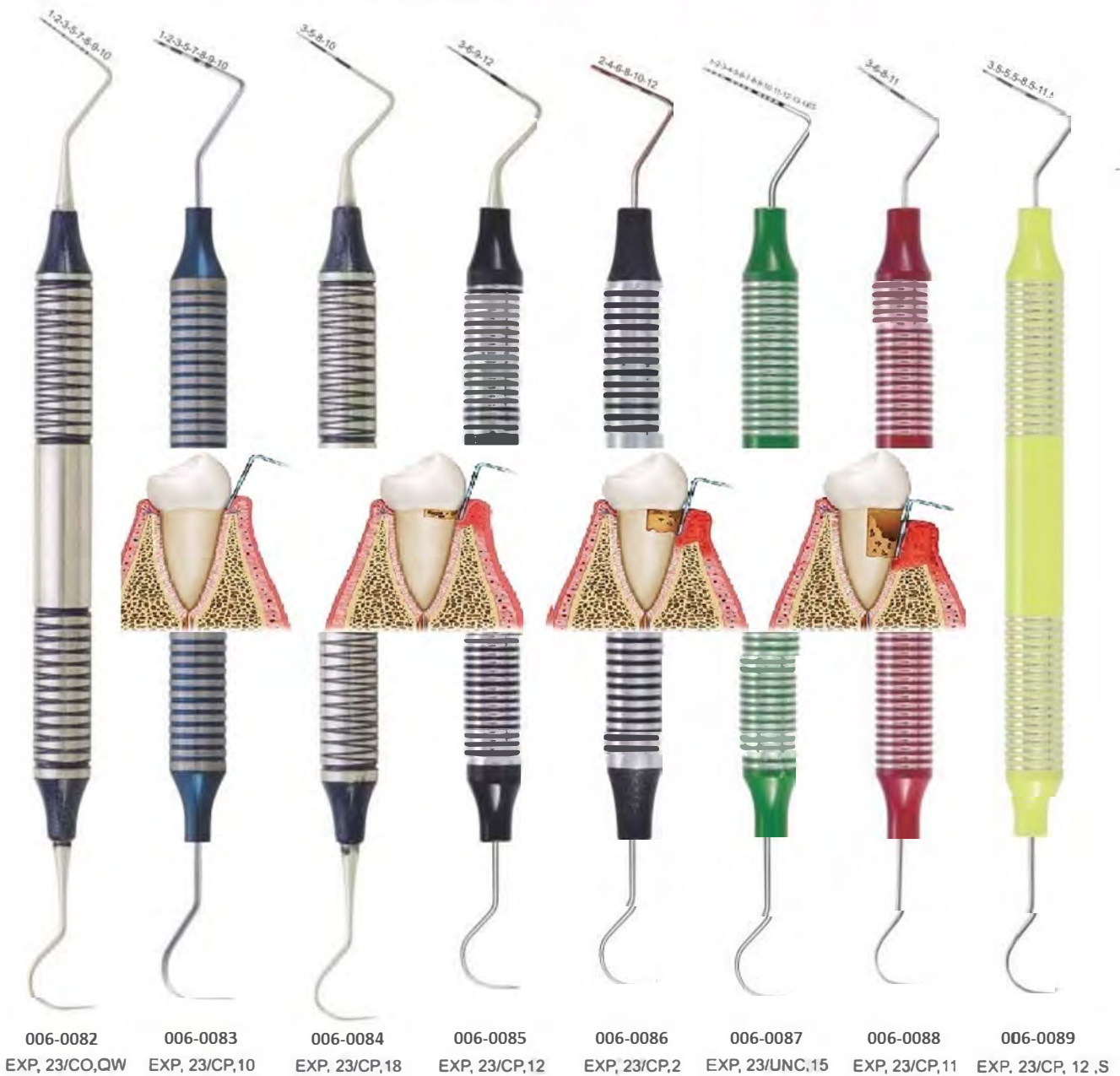



**PERIODONTAL INSTRUMENTS**  
 Struments Pour La parodontologie

**PERIODONTAL INSTRUMENTS SET OF 11 PCS**  
**SOLID HANDLE 6MM, LENGTH 170MM**

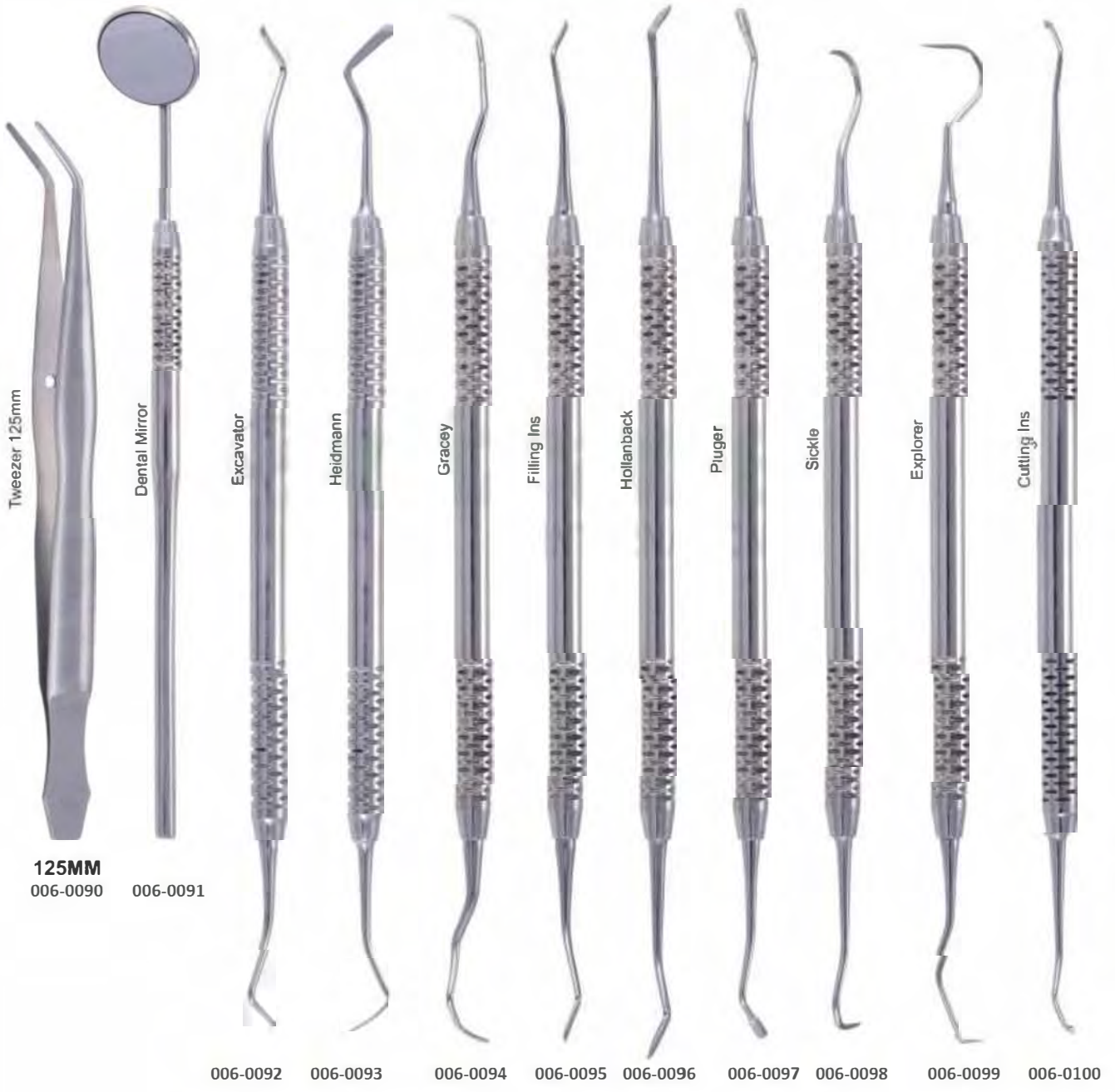





**GRACEY CURETTES**  
 Gracey Curetas

GRACEY SET OF 7 PCS HOLLOW HANDLE 9.5MM, LENGTH 170MM

0060101  
GRACEY  
1/2

006-0102  
GRACEY  
3/4

006-0103  
GRACEY  
5/6

006-0104  
GRACEY  
7/8

006-0105  
GRACEY  
9/10

006-0106  
GRACEY  
11/12

006-0107  
GRACEY  
13/14



**GRACEY CURETTES**  
 Gracey Curetas

**GRACEY SET OF 7 PCS**  
**HOLLOW HANDLE 9.5MM, LENGTH 170MM WITH SILICON GRIP**

| Model Number | Gracey Curette | Required Gracey Curettes                       |
|--------------|----------------|--|
| 006-0108     | GRACEY 1/2     | 1-2, 5-6, 7-8, 9-10, 11-12, 13-14 and/or 17-18 |
| 006-0109     | GRACEY 3/4     | 1-2, 5-6, 7-8, 9-10, 11-12, 13-14 and/or 17-18 |
| 006-0110     | GRACEY 5/6     | 1-2, 5-6, 7-8, 9-10, 11-12, 13-14 and/or 17-18 |
| 006-0112     | GRACEY 7/8     | 1-2, 5-6, 7-8, 9-10, 11-12, 13-14 and/or 17-18 |
| 006-0113     | GRACEY 9/10    | 1-2, 5-6, 7-8, 9-10, 11-12, 13-14 and/or 17-18 |
| 006-0114     | GRACEY 11/12   | 1-2, 5-6, 7-8, 9-10, 11-12, 13-14 and/or 17-18 |
| 006-0115     | GRACEY 13/14   | 1-2, 5-6, 7-8, 9-10, 11-12, 13-14 and/or 17-18 |



**GRACEY CURETTES**  
 Gracey Curetas

**GRACEY MINI FIVE**  
 HOLLOW HANDLE 9.5MM, LENGTH 170MM  
 CERAMIC COATED HANDLE

**GRACEY AFTER FIVE**  
 HOLLOW HANDLE 9.5MM, LENGTH 170MM  
 CERAMIC COATED HANDLE



006-0116 Gracey 1/2  
 006-0117 Gracey 3/4  
 006-0118 Gracey 5/6  
 006-0119 Gracey 7/8  
 006-0120 Gracey 11/12  
 006-0121 Gracey 13/14

006-0122 Gracey 1/2 AF  
 006-0123 Gracey 3/4 AF  
 006-0124 Gracey 5/6 AF  
 006-0125 Gracey 7/8 AF  
 006-0126 Gracey 11/12 AF  
 006-0127 Gracey 13/14 AF

Proper care must be given during cleaning, sharpening and sterilization to preserve design and integrity and to prolong usefulness. Do not expose instruments to sterilization temperatures above 350 F/177 C or to higher than recommended chemical concentrations.



**GRACEY CURETTES**  
 Gracey Curetas

**GRACEY CURETTE**  
**HOLLOW HANDLE 10MM, LENGTH 170MM**

Curetters Set of 8 Pieces



006-0128  
 Curette  
 Columbia  
 2L-2R

006-0129  
 Curette  
 Columbia  
 4L-4R

006-0130  
 Curette  
 McCall  
 13S-14S

006-0131  
 H6-H7  
 Scaler  
 Sickle

006-0132  
 H5-U15  
 Scaler  
 Sickle

006-0133  
 H5-13  
 Scaler  
 Sickle

006-0134  
 U15-30  
 Scaler  
 Sickle

006-0135  
 U15-33  
 Scaler  
 Sickle



**FILLING INSTRUMENTS**  
**Strumenti Per Otturazioni**

FILLING INSTRUMENTS (Gold Pointed)  
 SOLID HANDLE 6MM, LENGTH 170MM

| Instrument ID | Handle Width | Tip Size | Description                        | Length |
|---------------|--------------|----------|------------------------------------|--------|
| 006-0136      | 1.5mm        | 1/1      | Filling instrument, spatula        | 170 mm |
| 006-0137      | 2.0mm        | 1/1      | Filling instrument, spatula        | 170 mm |
| 006-0138      | 2.0mm        | 1/1      | Filling instrument, spatula        | 170 mm |
| 006-0139      | 2.5mm        | 1/1      | Filling instrument                 | 175 mm |
| 006-0140      | 1.3mm        | 0.9mm    | Filling instrument, ball           | 170 mm |
| 006-0141      | 1.6mm        | 1.3mm    | Filling instrument, ball           | 170 mm |
| 006-0142      | 2.4mm        | 1.8mm    | Filling instrument, ball           | 170 mm |
| 006-0143      | 2.4mm        | 2.0mm    | Filling instrument, ball / spatula | 175 mm |
| 006-0144      | 1.3mm        | 1.5mm    | Filling instrument, plan / plan    | 165 mm |
| 006-0145      | 1.8mm        | 1.2mm    | Filling instrument, plan / plan    | 165 mm |



**EXPLOERS INSTRUMENTS**  
**Sonda Doppio**

**EXPLORERS INSTRUMENTS**  
**SOLID HANDLE 6MM, LENGTH 170MM**

**PLUGGERS**

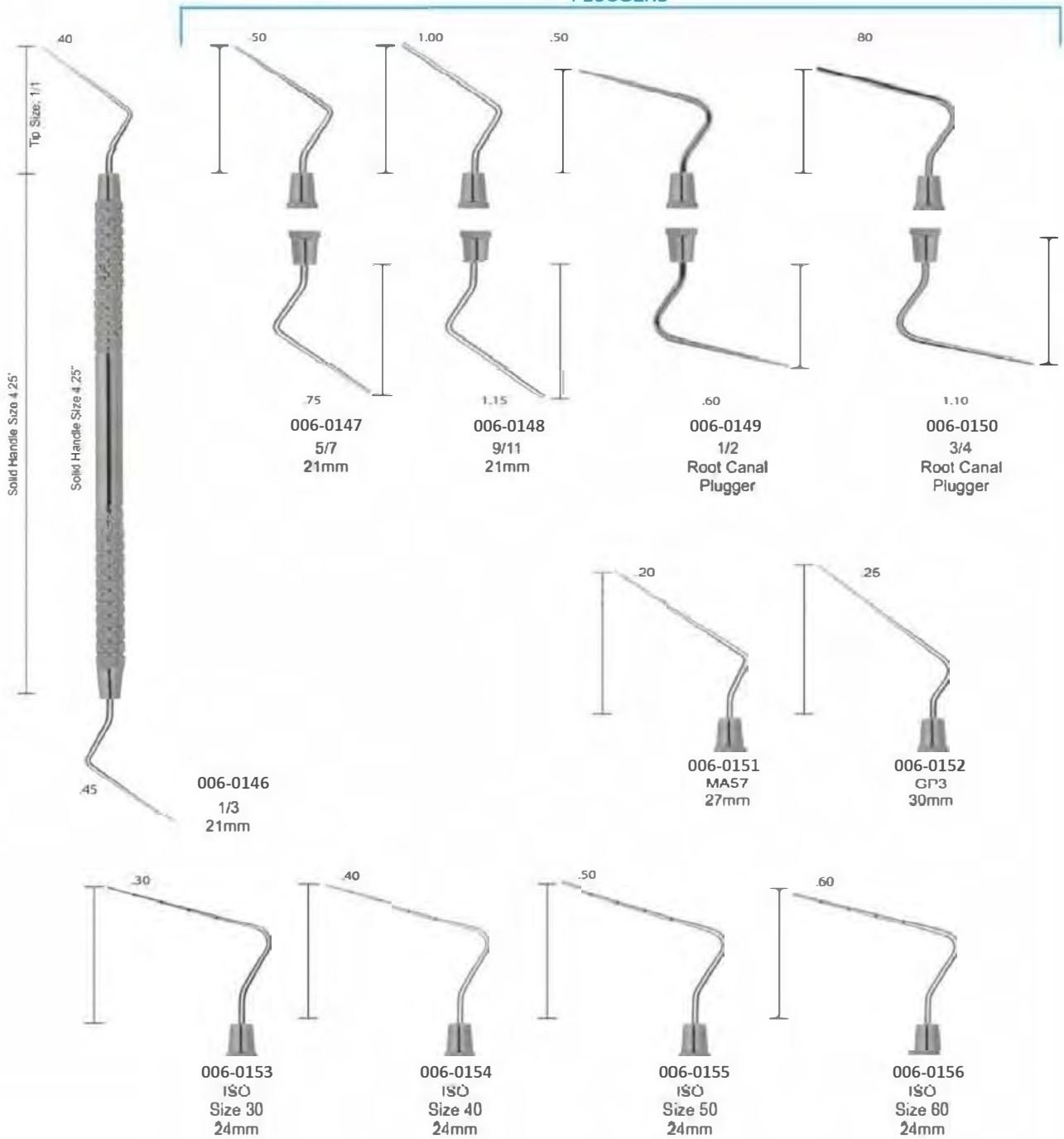



**PERIODONTAL PROBES**  
**Sonde Parodontali**

**SPREADERS**

**HEAT CARRIERS**

|   |                 |                 |                 |          |               |               |                  |              |     |
|---|-----------------|-----------------|-----------------|----------|---------------|---------------|------------------|--------------|-----|
|  <p>Tip Size: 1/1</p> <p>Solid Handle Size 4.25"</p> | .30             | .40             | .50             | .60      | .25           | .30           | .40              | .40          | .35 |
|   | 006-0158        | 006-0159        | 006-0160        | 006-0161 | 006-0162      | 0060163       | 006-0164         | 006-0165     |     |
|   | ISO             | ISO             | ISO             | GP1      | 1S            | 2S            | D11              | D11S         |     |
|   | Size 40<br>24mm | Size 50<br>28mm | Size 60<br>28mm | 20mm     | Wakai<br>22mm | Wakai<br>22mm | Standard<br>23mm | Thin<br>23mm |     |

**HEAT CARRIERS**

|                 |                 |                  |          |          |          |          |
|-----------------|-----------------|------------------|----------|----------|----------|----------|
| 006-0157        | 006-0166        | 006-0167         | 006-0168 | 006-0169 | 006-0170 | 006-0171 |
| ISO             | D11T            | D11TS            | 3        | GP2      | 0‡       | 00‡      |
| Size 30<br>24mm | Thinner<br>22mm | Thinnest<br>21mm | 28mm     | 25mm     | 25mm     | 25mm     |



**PERIODONTAL PROBES**  
 Sonde Parodontali

**ANTERIOR**

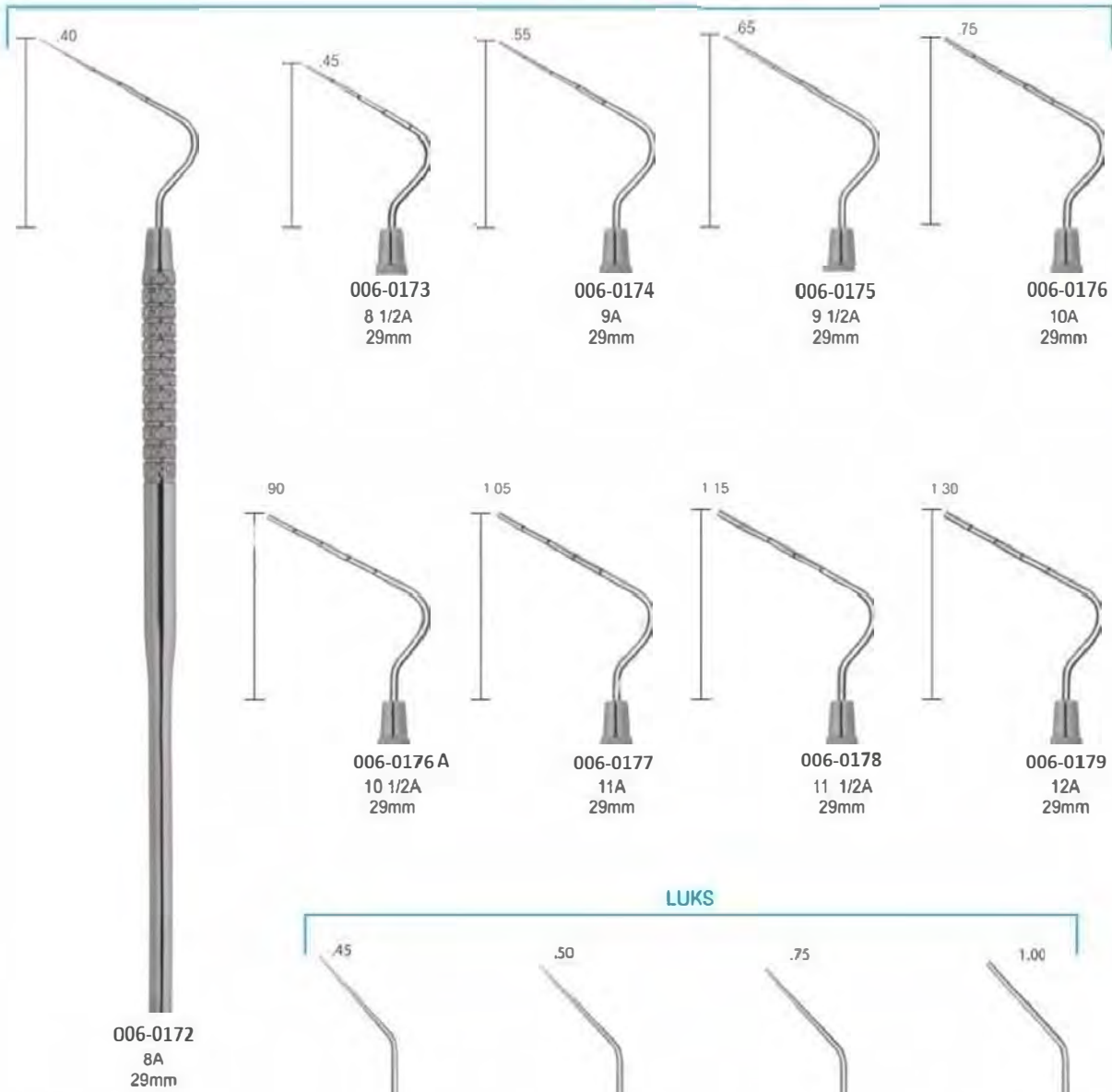

**LUKS**







**PERIODONTAL PROBES**  
**Sonde Parodontali**

ENDODONTICS INSTRUMENTS SOLID HANDLE 6MM, LENGTH 170MM

RETRO FILLING  
PLUGGERS

POSTERIOR

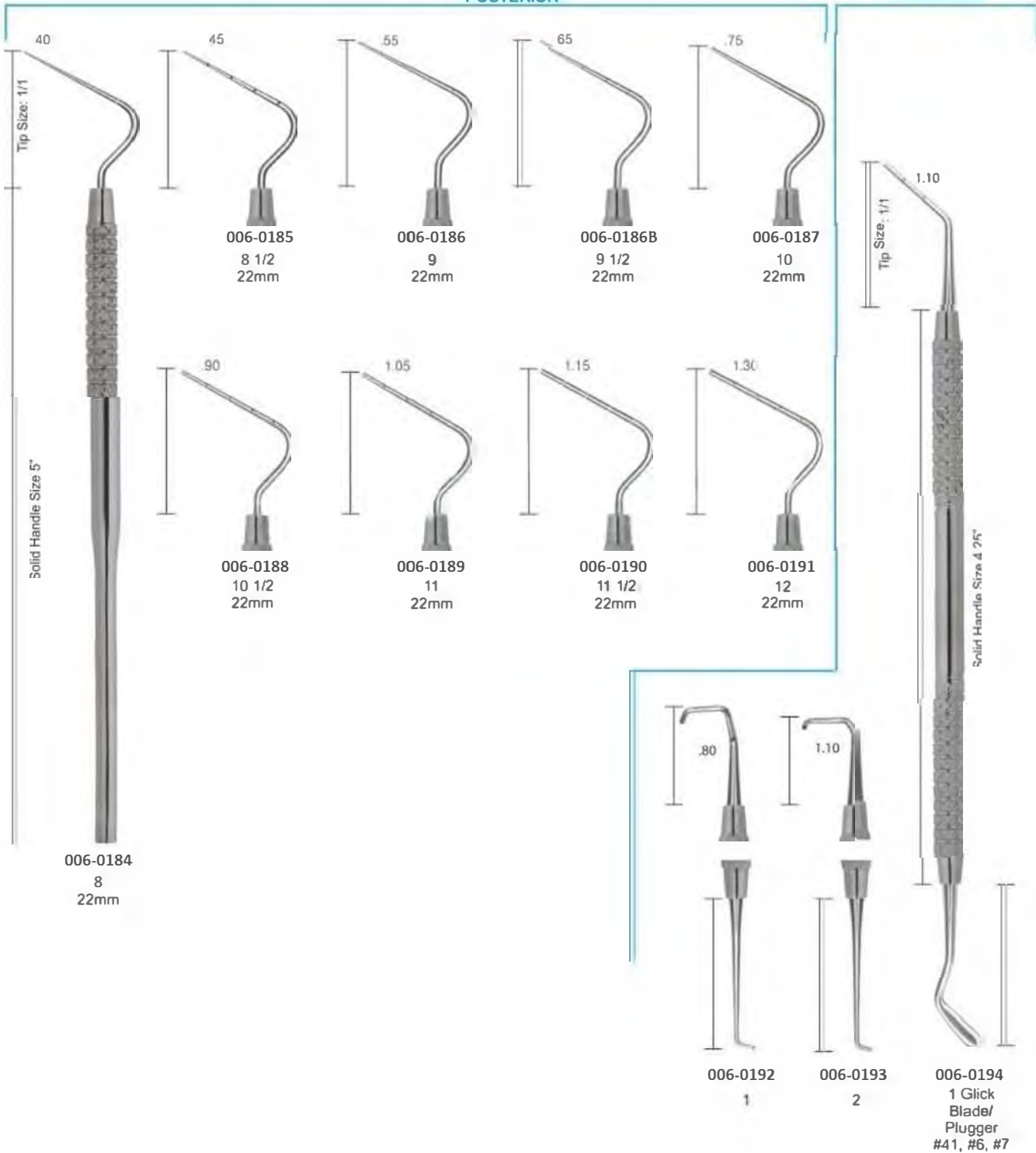



**FILLING INSTRUMENTS**  
 Strumenti Per Otturazioni

COMPOSITE/PLASTIC FILLING INSTRUMENTS SOLID HANDLE 6MM, LENGTH 170MM

POSTERIOR

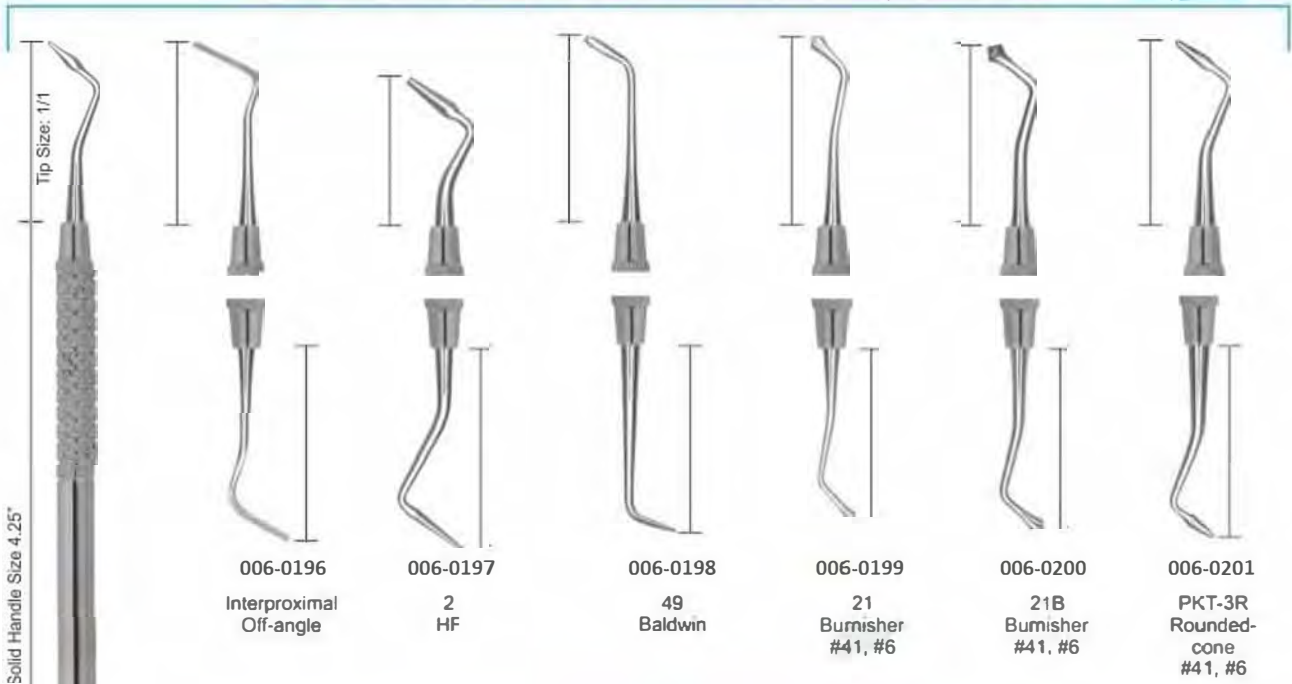

UNIVERSAL FILLING INSTRUMENTS

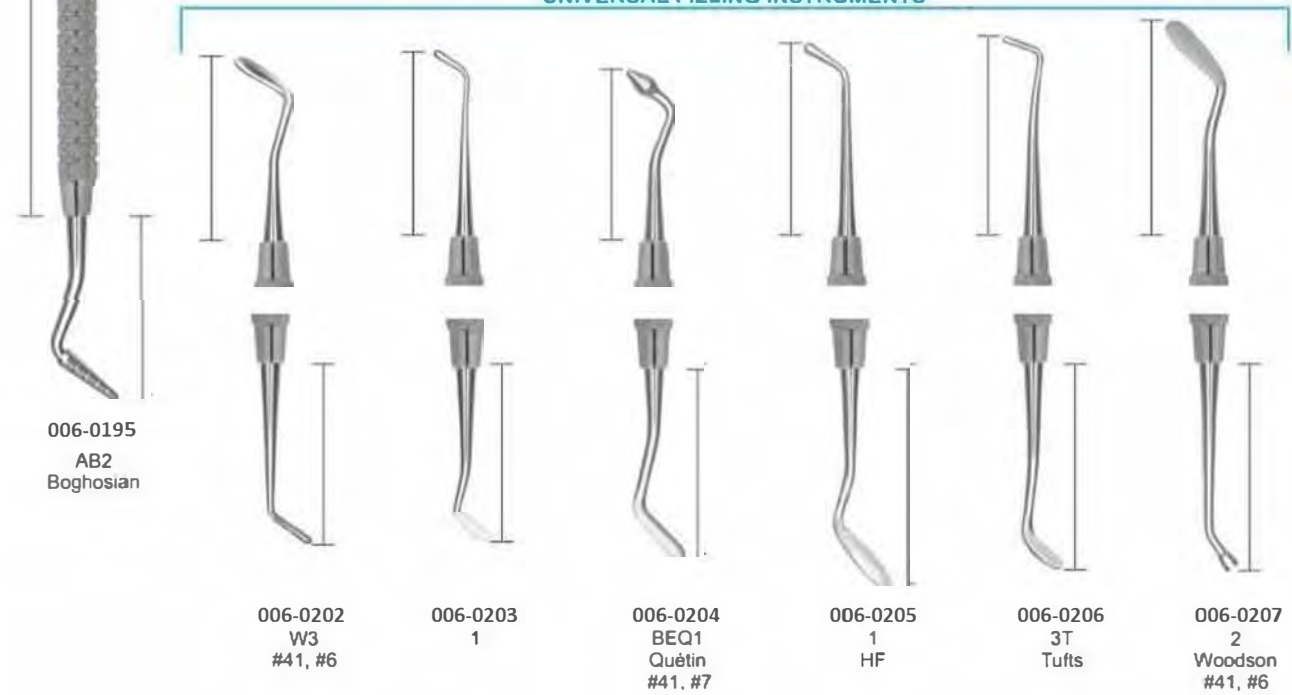



**FILLING INSTRUMENTS**  
**Strumenti Per Otturazioni**

COMPOSITE/PLASTIC FILLING INSTRUMENTS SOLID HANDLE 6MM, LENGTH 170MM

BLACK

PLUGGERS/CONDENSERS

Hollenback

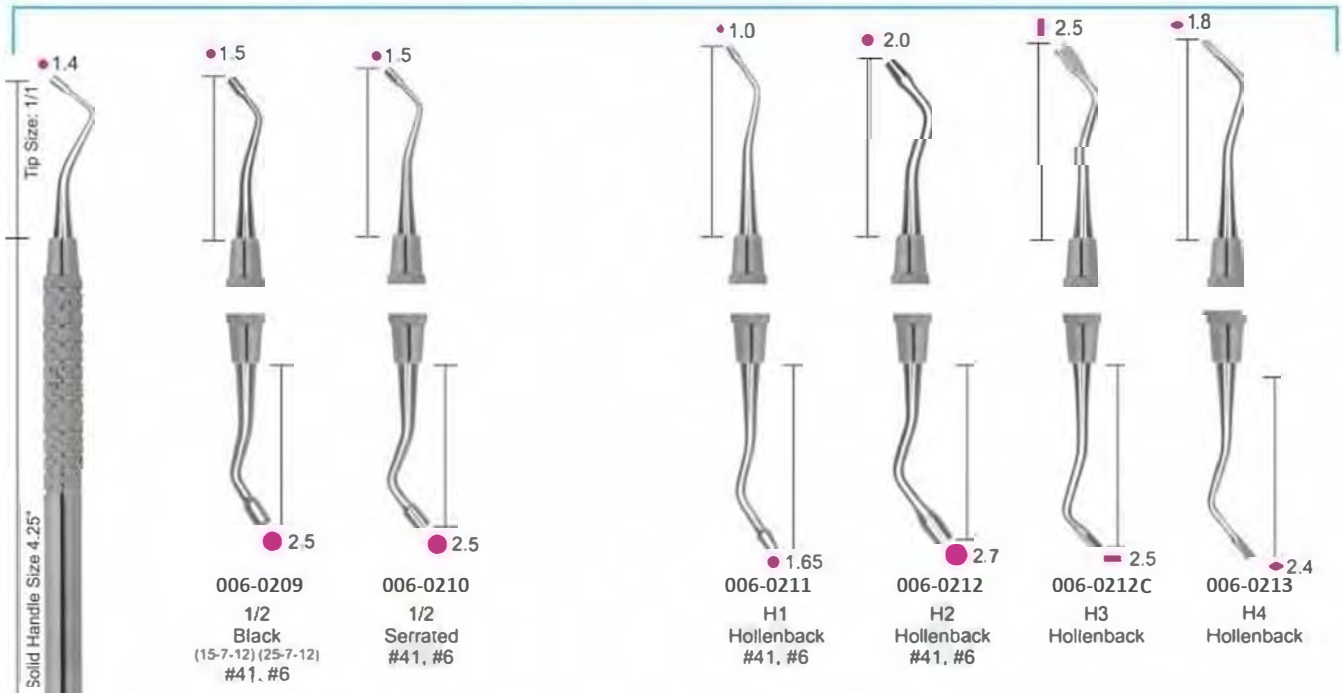

**MARQUETTE CONDENSER**

**MORTONSON**

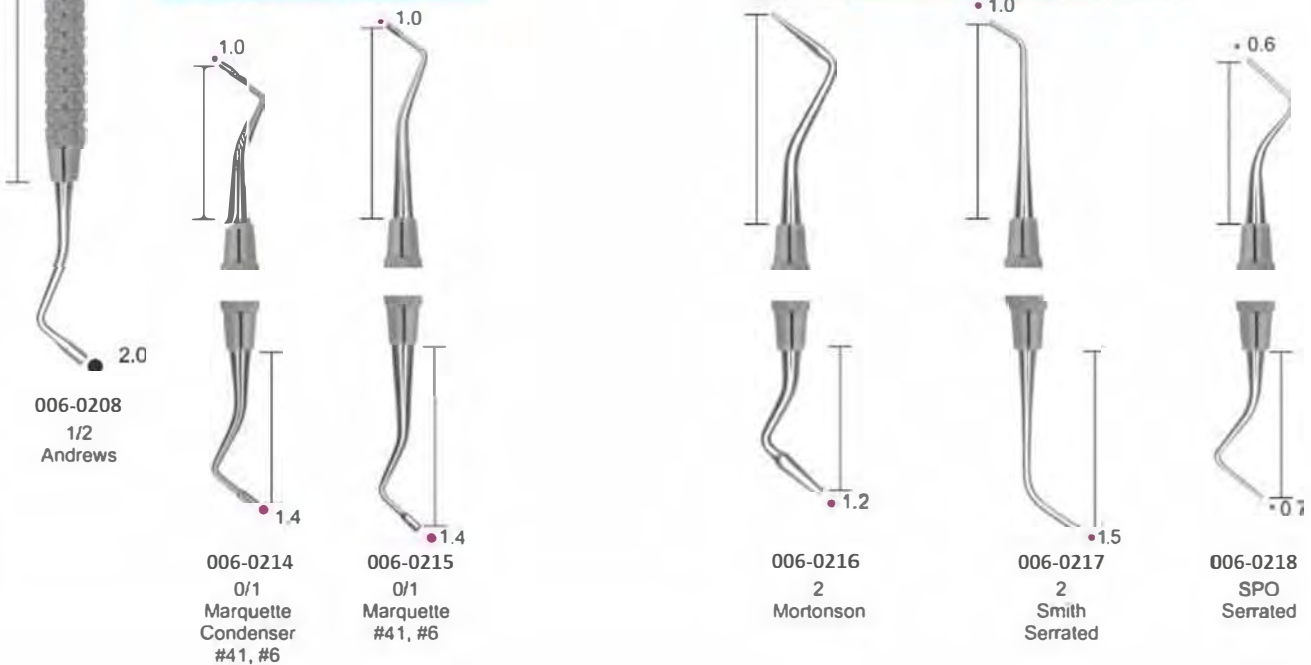



**AMALGAM PLUGGERS/CONDENSERS**  
**Otturatori/Condensatori Per Amalgama**

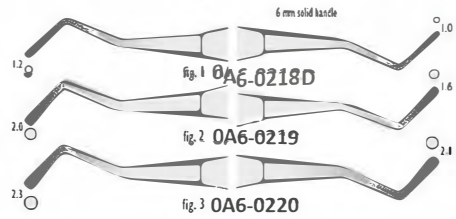

Falcon

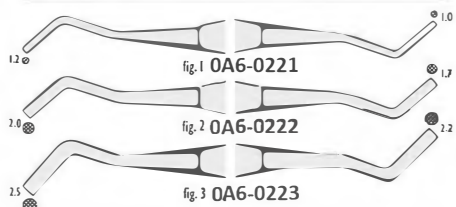

Falcon

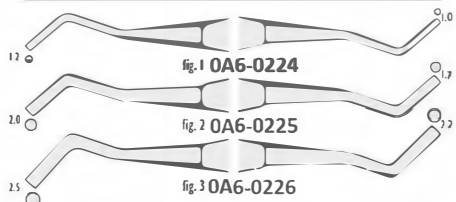

Wards



Markley

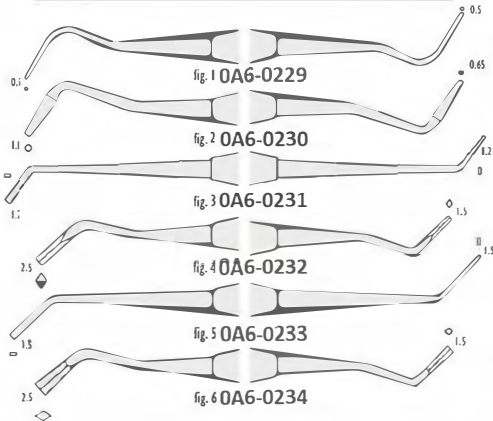

Standard

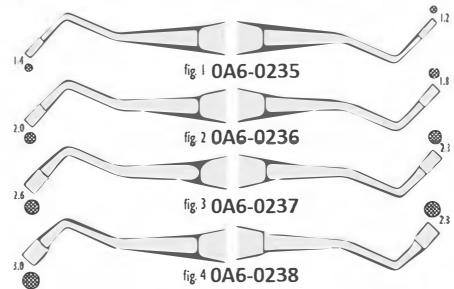

Standard

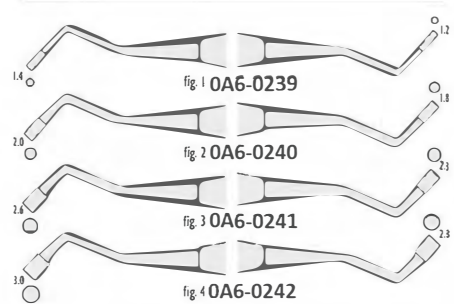

Mall

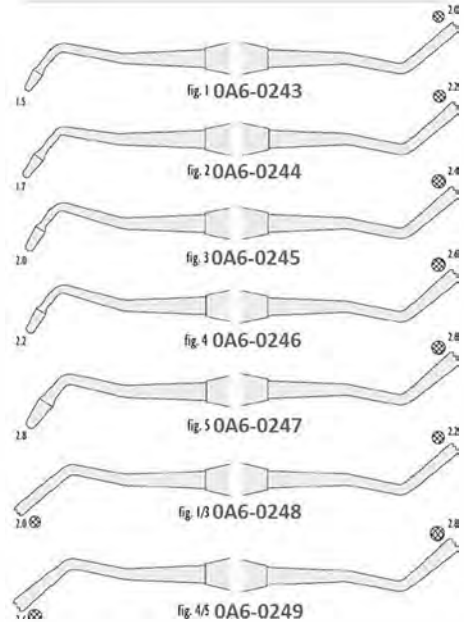



**AMALGAM PLUGGERS/CONDENSERS**  
**Otturatori/Condensatori Per Amalgama**



Super Plugger Blue - Yellow

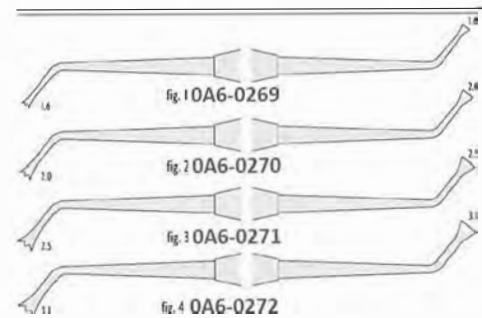
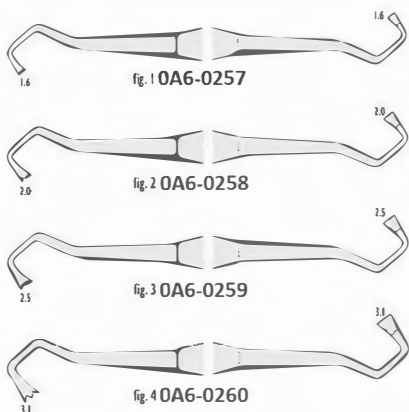
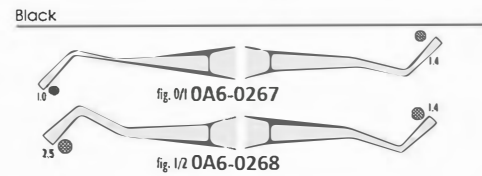
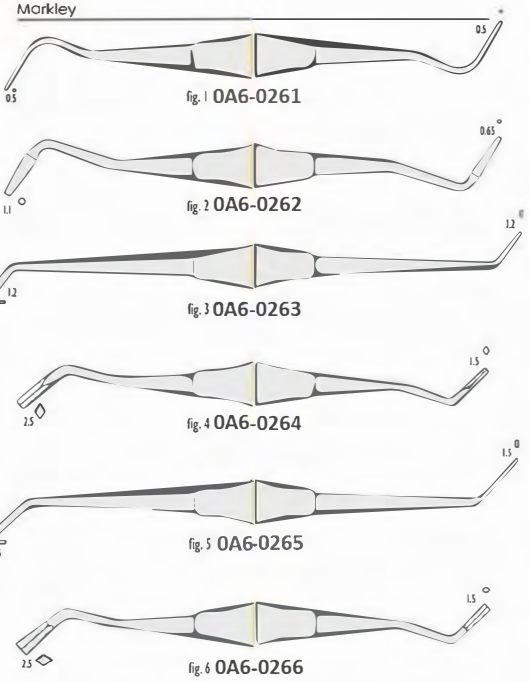
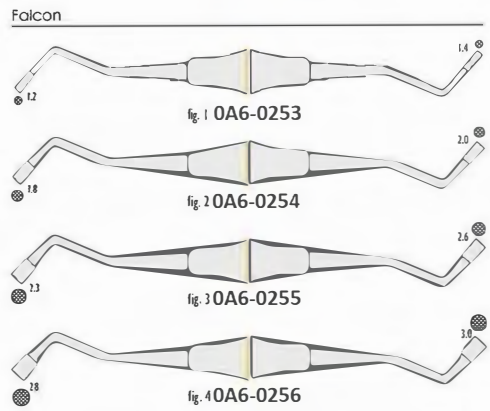
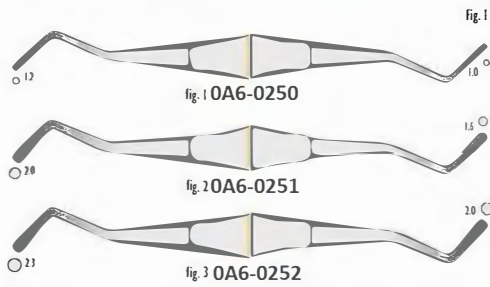



**BURNISHERS**  
 Brunitori

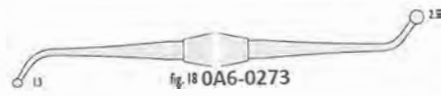

Acorn / Wescott



Beavertail / White

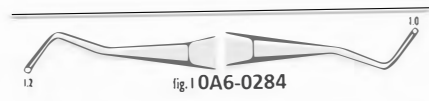
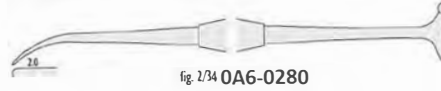

White

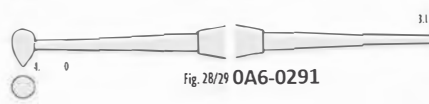
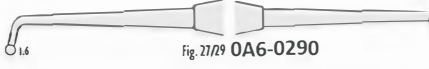
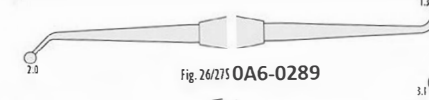

10 mm hollow handle



Acorn / Wescott

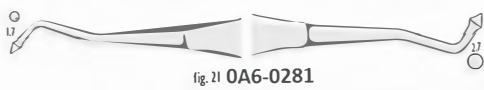

White

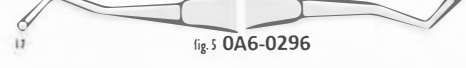
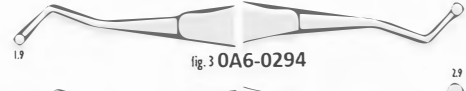
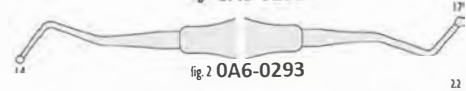
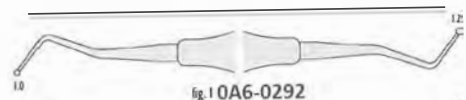



**BURNISHERS**  
 Brunitori



Blue - Yellow

**Acorn/Wescott**



fig. 21 OA6-0297



fig. 21B OA6-0298

**White**



fig. 27/29 OA6-02994

**Freedman**



fig. 3 OA6-0300

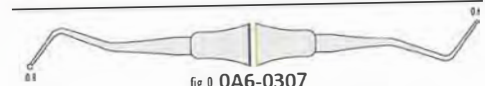

fig. 0 OA6-0307



fig. 1 OA6-0308



fig. 2 OA6-0309



fig. 3 OA6-0310



fig. 4 OA6-0311



fig. 5 OA6-0312



fig. 1 OA6-0301



fig. 2 OA6-0302



fig. 3 OA6-0303



fig. 1 OA6-0304



fig. 11 OA6-0305

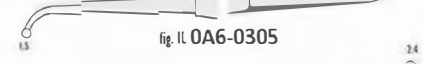

fig. 18 OA6-0306



fig. 1 OA6-0313

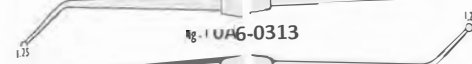

fig. 2 OA6-0314



fig. 3 OA6-0315

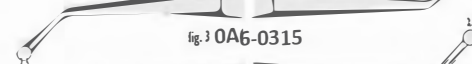

fig. 4 OA6-0316

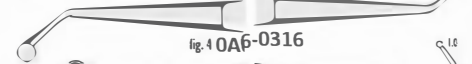

fig. 1 OA6-0317



fig. 2 OA6-0318

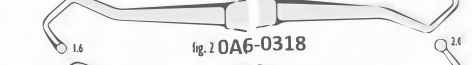

fig. 2 OA6-0318



fig. 3 OA6-0319



fig. 10 OA6-0320



**FILLING INSTRUMENTS**  
**Strumenti Per Otturazioni**

**PLUGGERS/CONDENSERS**

RESTORATIVE INSTRUMENTS SOLID HANDLE 6MM, LENGTH 170MM

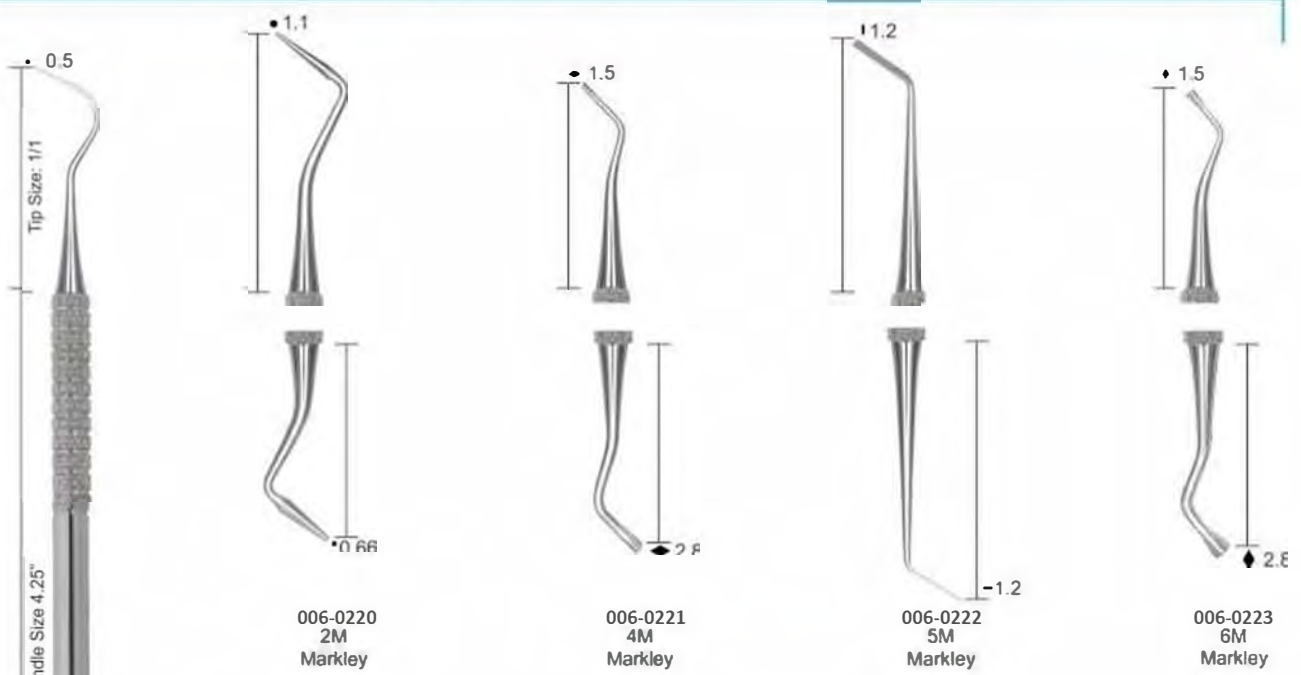

**PLUGGERS/CONDENSERS**

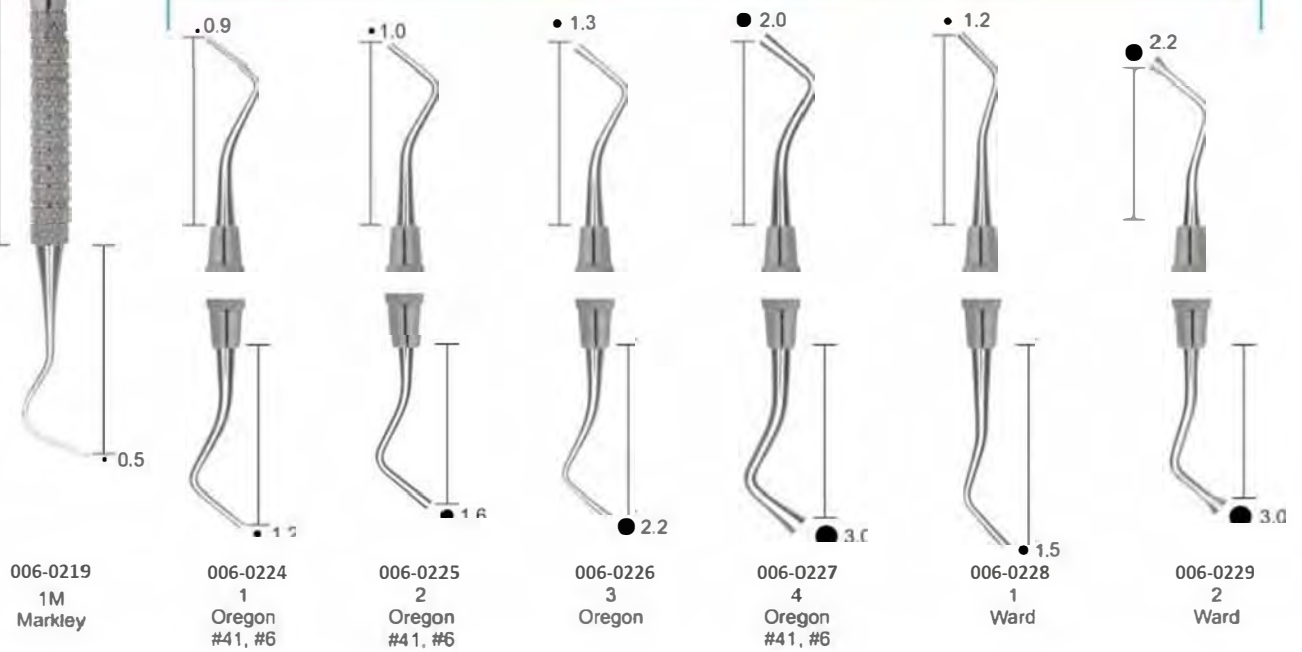





**FILLING INSTRUMENTS**  
**Strumenti Per Otturazioni**

RESTORATIVE INSTRUMENTS SOLID HANDLE 6MM, LENGTH 170MM  
 Back Action Filling Instruments

Tanner Filling Instruments

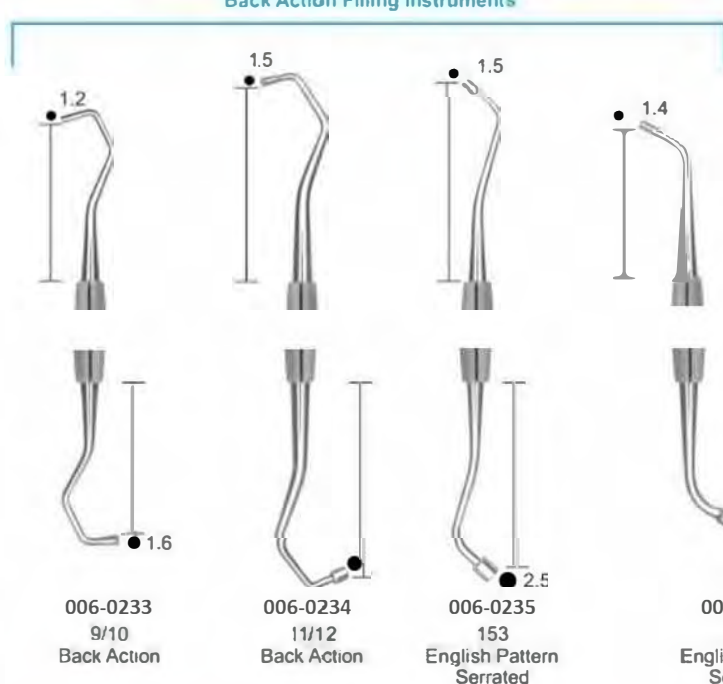
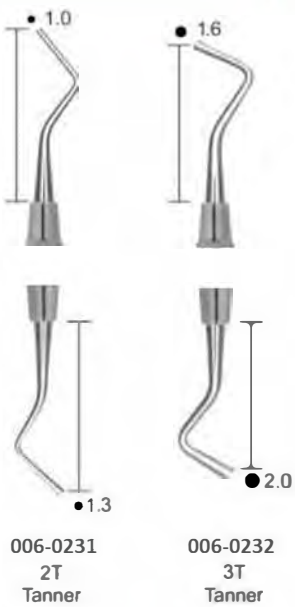
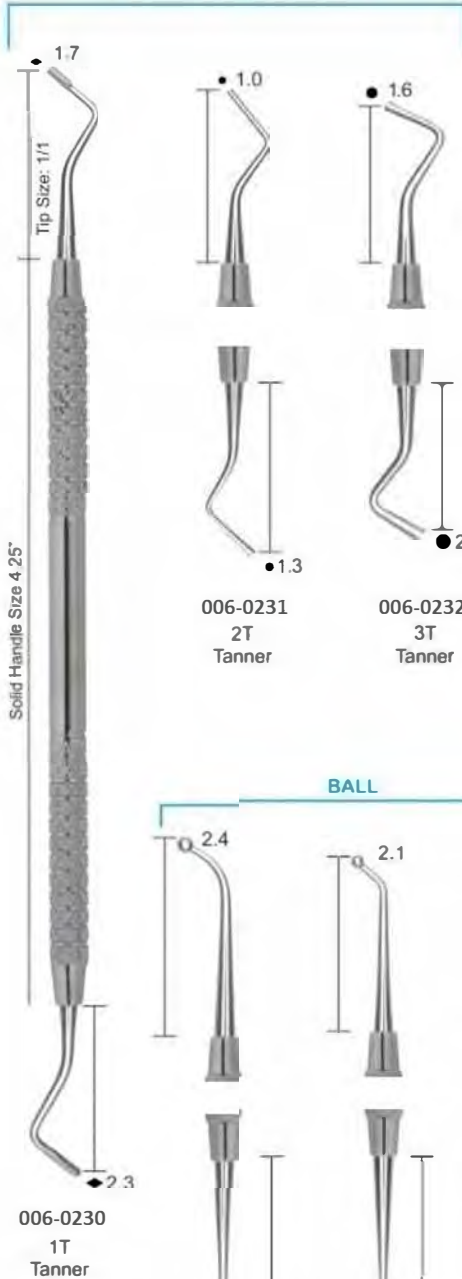

006-0230  
 1T  
 Tanner

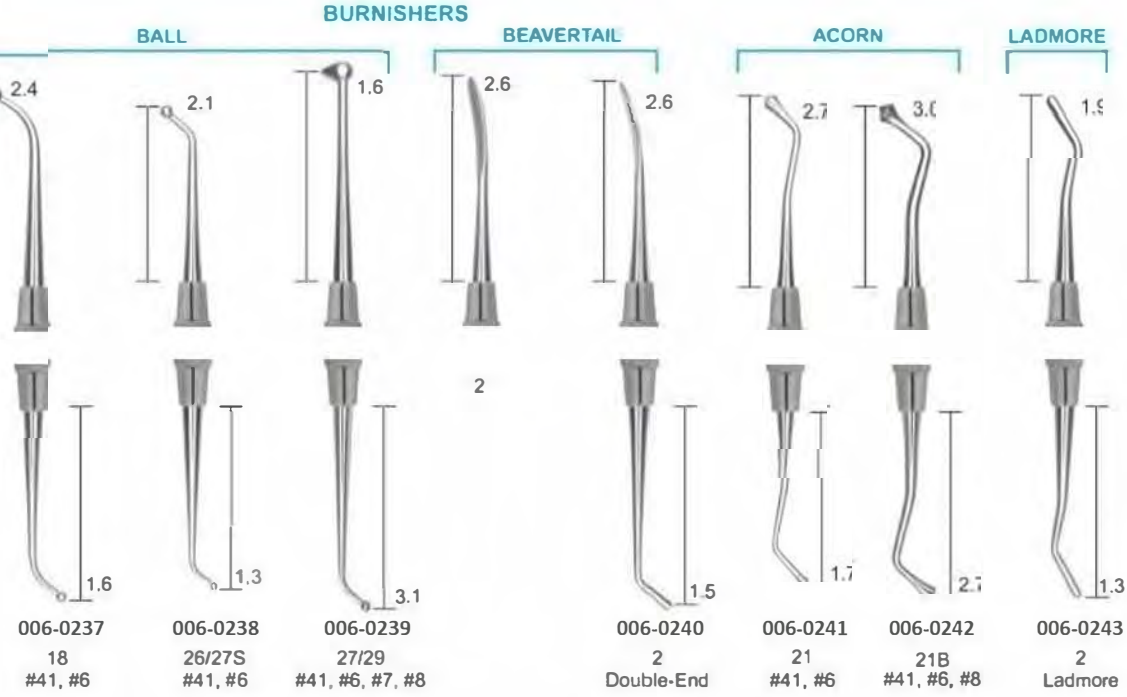



**FILLING INSTRUMENTS**  
**Strumenti Per Otturazioni**

RESTORATIVE INSTRUMENTS SOLID HANDLE 6MM, LENGTH 170MM

**BURNISHERS**

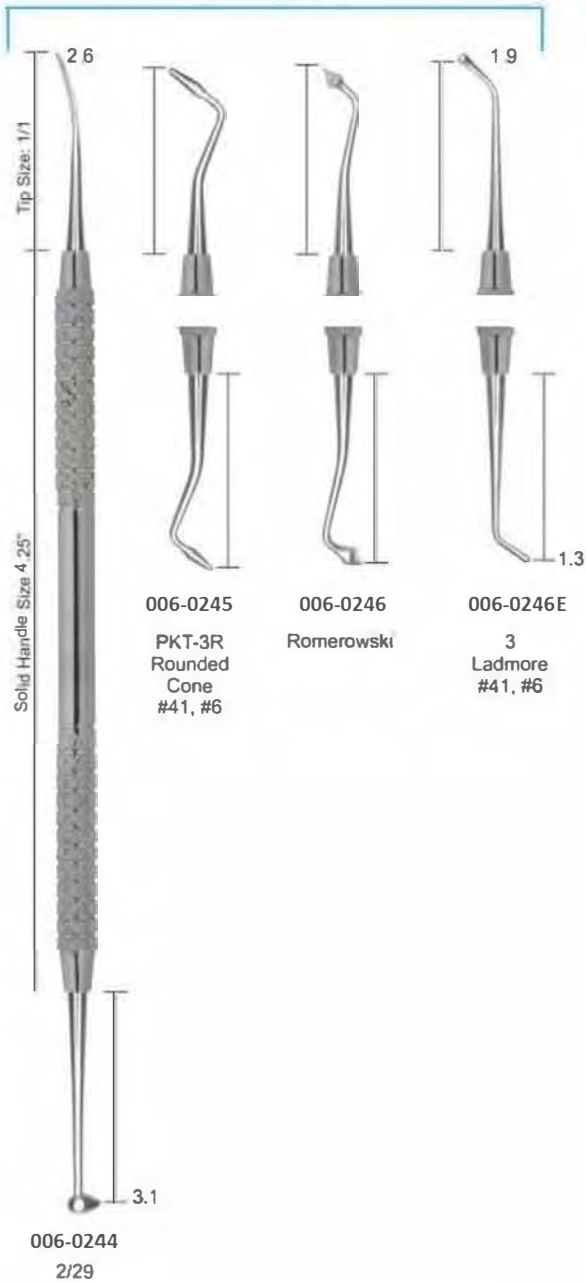

**PERIODONTAL FILES**

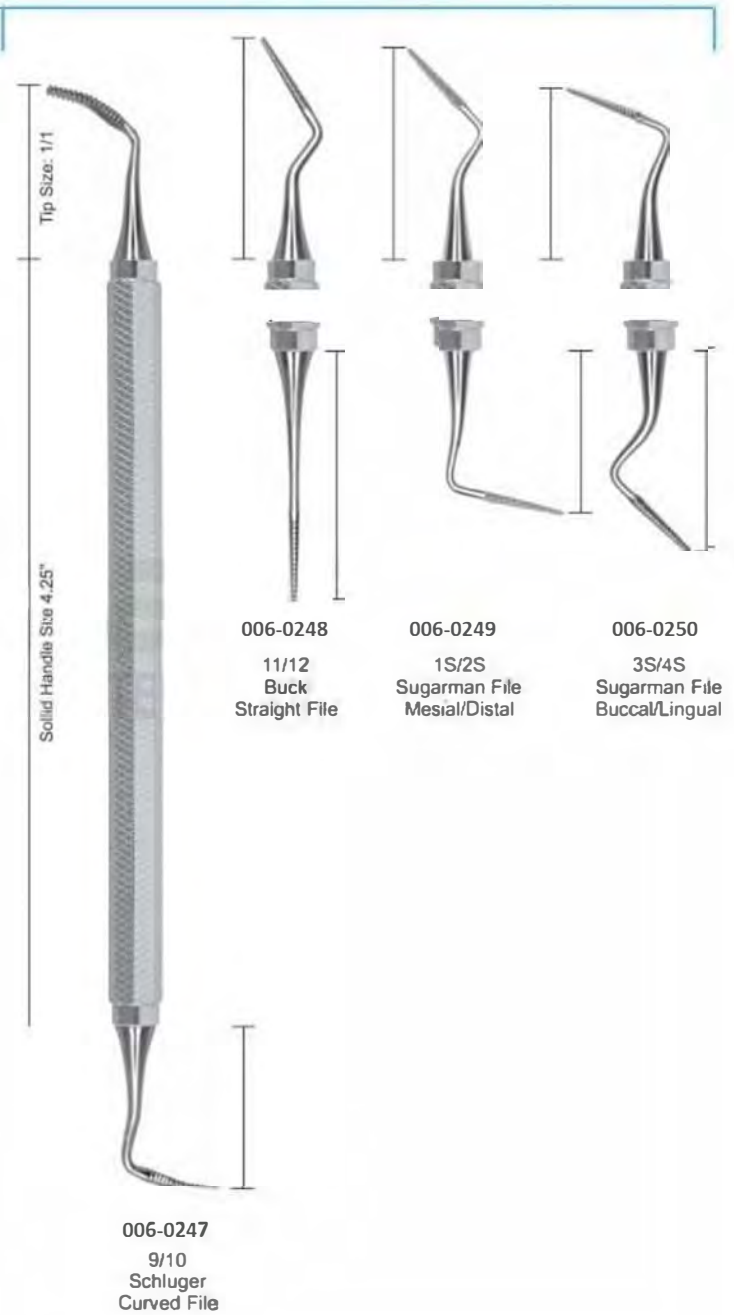



**FILLING INSTRUMENTS**  
**Strumenti Per Otturazioni**

**BURNISHER FILLING INSTRUMENTS**

COMPOSITE/PLASTIC FILLING INSTRUMENTS  
 SOLID HANDLE 6MM, LENGTH 170MM

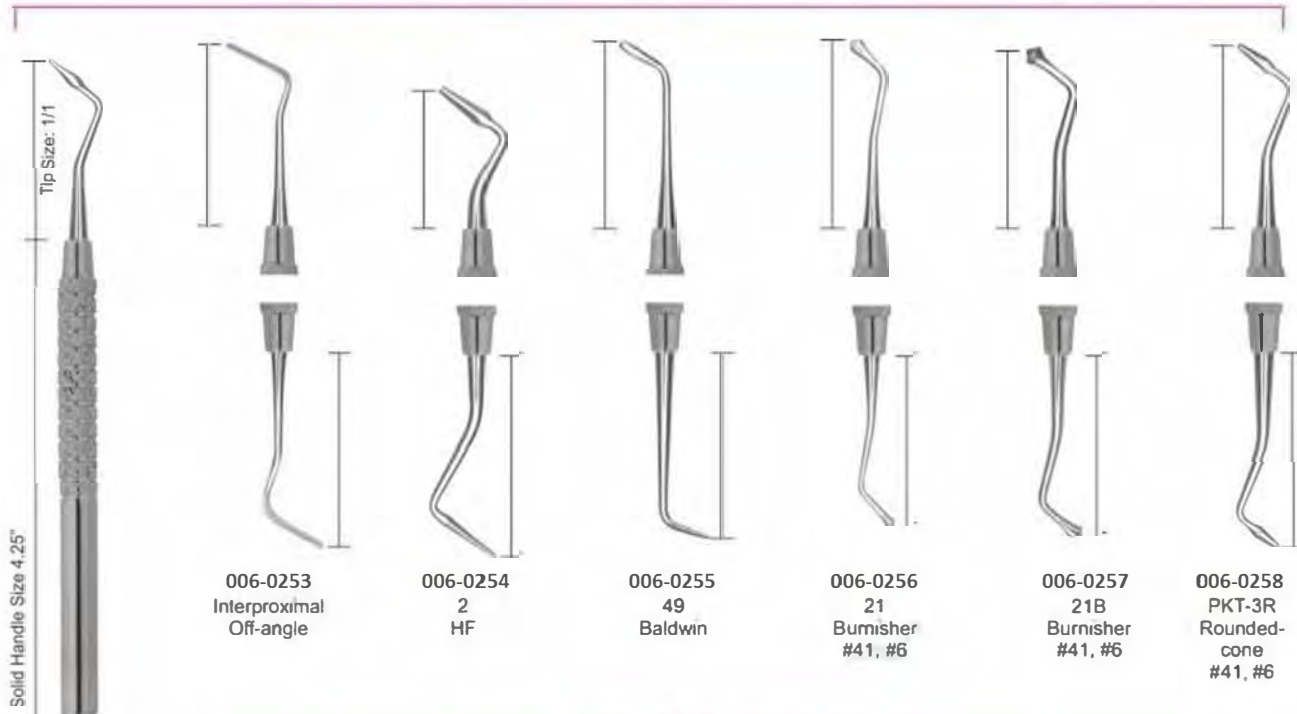

006-0253  
 Interproximal  
 Off-angle

006-0254  
 2  
 HF

006-0255  
 49  
 Baldwin

006-0256  
 21  
 Burnisher  
 #41, #6

006-0257  
 21B  
 Burnisher  
 #41, #6

006-0258  
 PKT-3R  
 Rounded-  
 cone  
 #41, #6

**UNIVERSAL FILLING INSTRUMENTS**

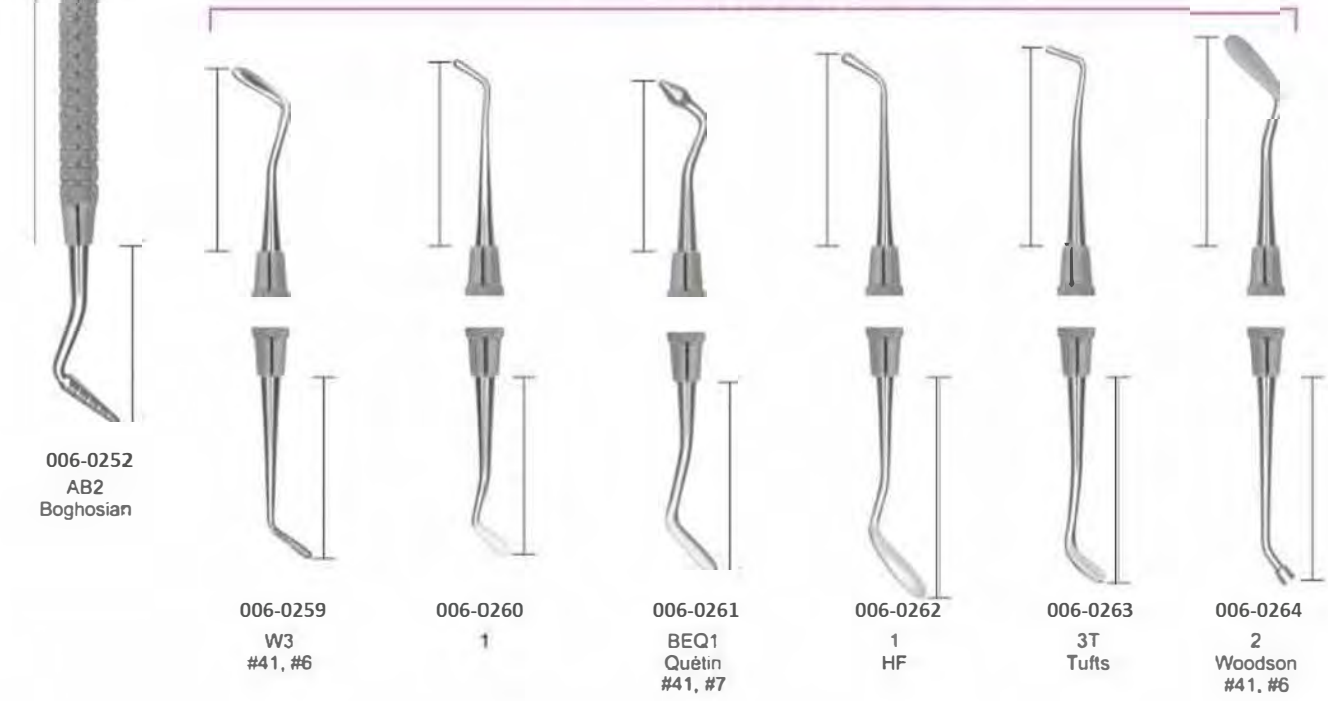

006-0252  
 AB2  
 Boghosian

006-0259  
 W3  
 #41, #6

006-0260  
 1

006-0261  
 BEQ1  
 Quélin  
 #41, #7

006-0262  
 1  
 HF

006-0263  
 3T  
 Tufts

006-0264  
 2  
 Woodson  
 #41, #6



**FILLING INSTRUMENTS**  
 Strumenti Per Otturazioni

**FILLING INSTRUMENTS**  
 SOLID HANDLE 6MM, LENGTH 170MM

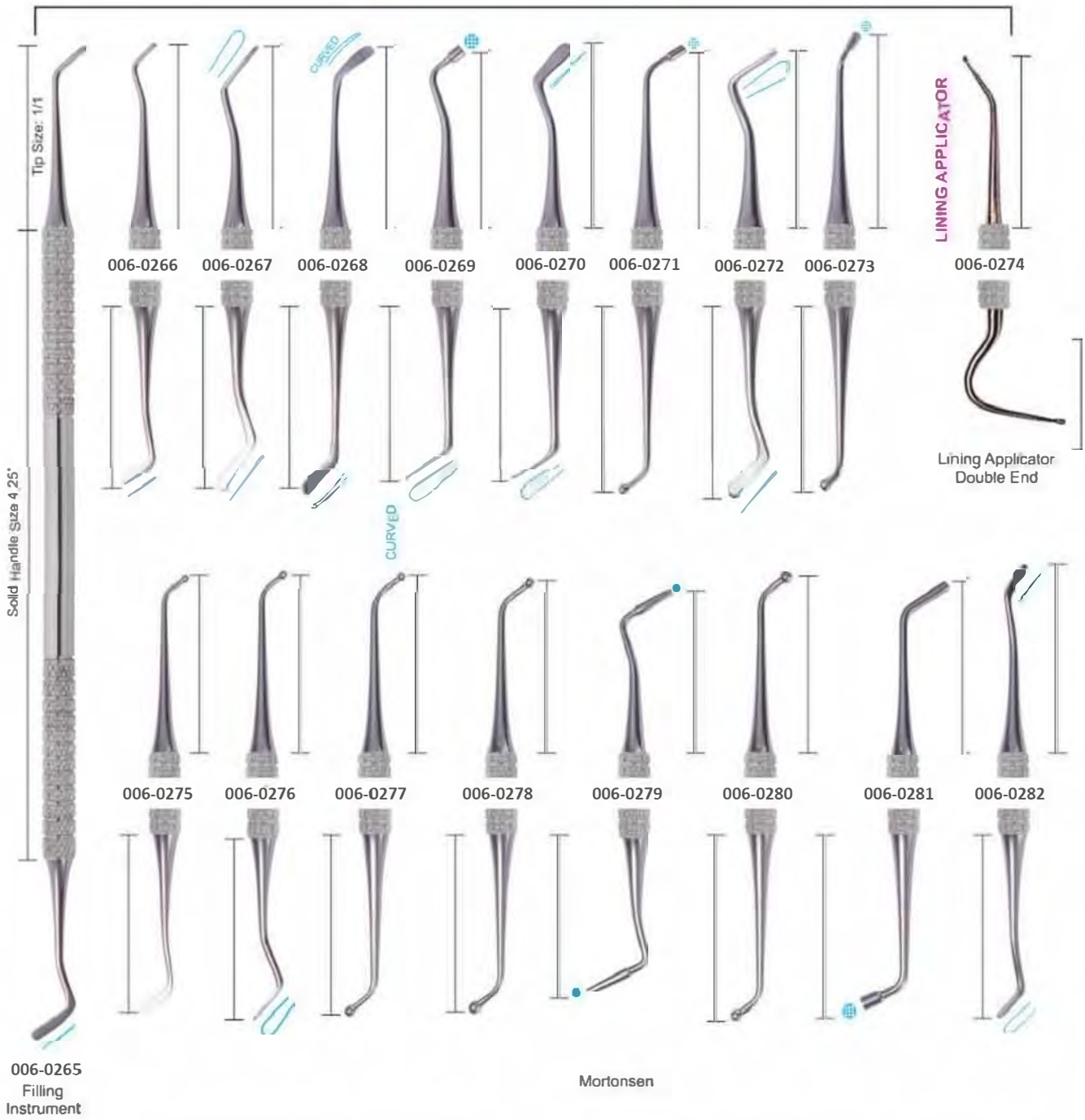



**FILLING INSTRUMENTS**  
 Strumenti Per Otturazioni

AMALGAM INSTRUMENTS  
 SOLID HANDLE 6MM, LENGTH 170MM

Excavators Instruments Set of 11 Pieces

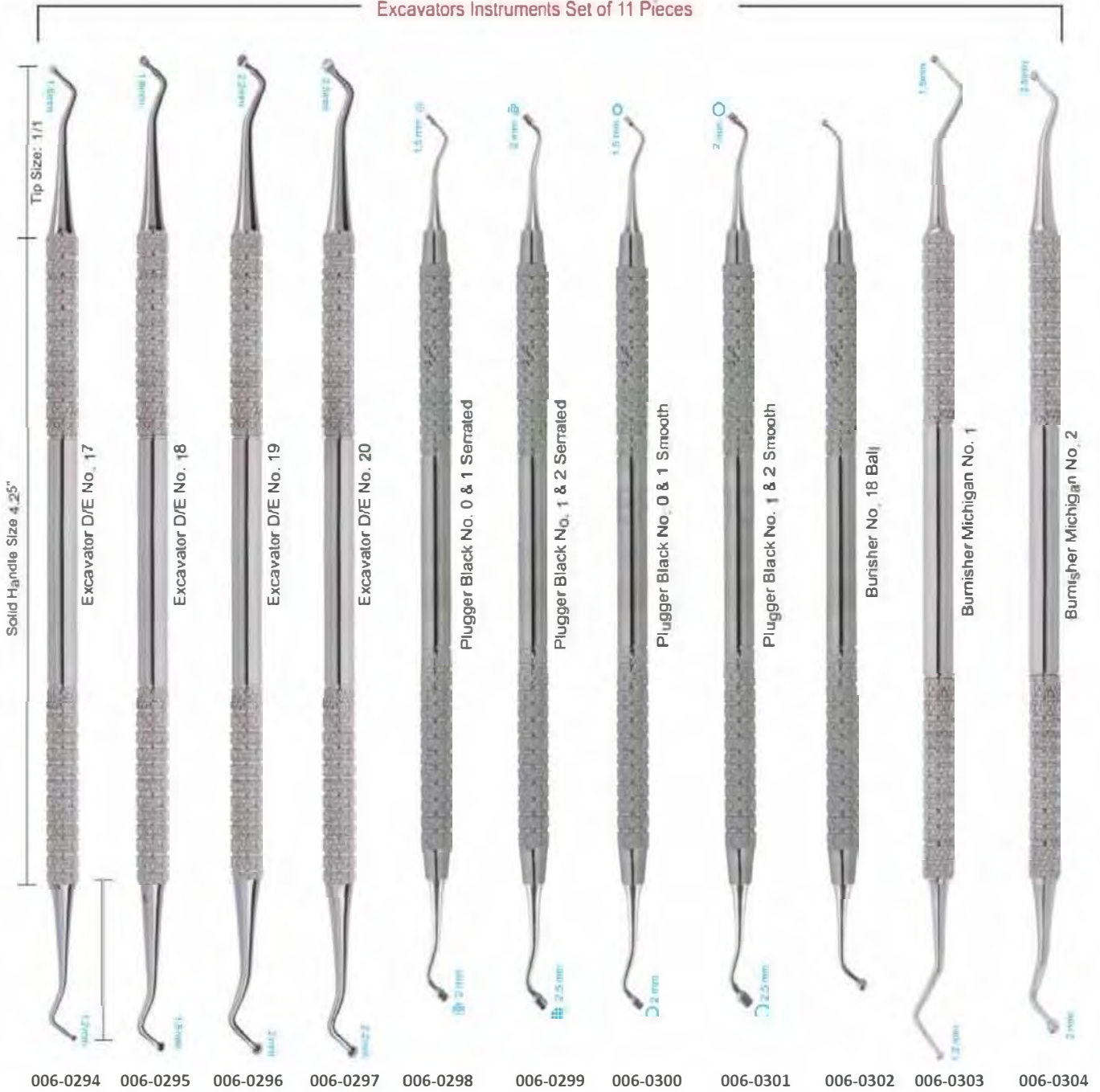



**PERIODONTAL INSTRUMENTS**  
**Strumenti Per Parodontologie**

**SICKLE SCALERS INSTRUMENTS SOLID HANDLE 6MM, LENGTH 170MM**

**SICKLE SCALERS**





**PERIODONTAL INSTRUMENTS**  
**Strumeni Per Parodontologie**

PERIODONTAL INSTRUMENTS SOLID HANDLE 6MM, LENGTH 170MM  
**JACQUETTE SCALERS**

**CRANE-KAPLAN**





**PERIODONTAL INSTRUMENTS**  
**Strumenti Per Parodontologie**

PERIODONTAL INSTRUMENTS SOLID HANDLE 6MM, LENGTH 170MM  
 SCALER/CURETTE SETS







**CURETTES**  
 Curetas

**SCALER/CURETTE SETS**

**GOLDMAN-FOX SET**

Tip Size: 1/1

Solid Handle Size 4.25"

| Model Number | Instrument Name | Tip Size      | Handle Size | Length |
|--------------|-----------------|---------------|-------------|--------|
| 006-0325     | 103/106         | #4, #6        | 6mm         | 170mm  |
| 006-0326     | 104/105         | Hoe/Chisel    | 6mm         | 170mm  |
| 006-0327     | 107/108         | #2, #4, #6    | 6mm         | 170mm  |
| 006-0328     | 107/108S        | Modied        | 6mm         | 170mm  |
| 006-0329     | 1/2 (shown)     | #2, #4, #6    | 6mm         | 170mm  |
| 006-0330     | 3/4† (shown)    | #2, #4, #6    | 6mm         | 170mm  |
| 006-0331     | 5/6† (shown)    | #2, #4, #6    | 6mm         | 170mm  |
| 006-0332     | 7/8† (shown)    | #2, #4, #6    | 6mm         | 170mm  |
| 006-0333     | 1/2 Rigid       | #2, #4, #6    | 6mm         | 170mm  |
| 006-0334     | 3/4 Rigid       | #2, #4, #6    | 6mm         | 170mm  |
| 006-0335     | 5/6 Rigid       | #2, #4, #6    | 6mm         | 170mm  |
| 006-0336     | 5/6 Extra Rigid | #4, #6 #7, #8 | 6mm         | 170mm  |
| 006-0337     | 7/8 Rigid       | #2, #4, #6    | 6mm         | 170mm  |
| 006-0338     | 7/8 Extra Rigid | #2, #4, #6    | 6mm         | 170mm  |

**SCALER/CURETTE SETS INSTRUMENTS**  
**SOLID HANDLE 6MM, LENGTH 170MM**



**CURETTES**  
 Curetás

GRACEY CURETTE INSTRUMENTS SOLID HANDLE 6MM, LENGTH 170MM

GRACEY CURETTES

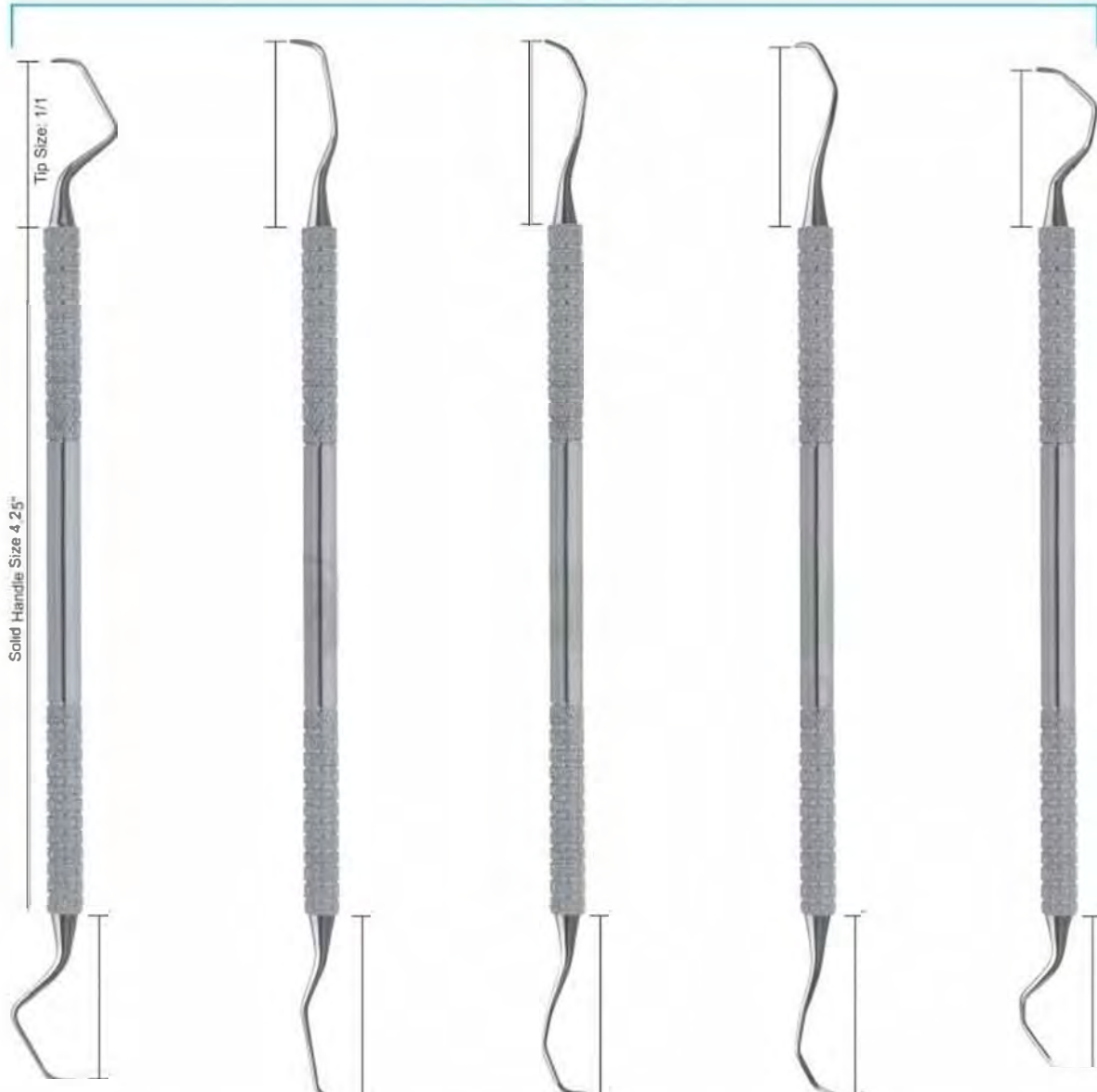

006-0339  
 9/10†  
 (shown)  
 #2, #4, #6  
 #7, #8, #9

006-0340  
 11/12†  
 (shown)  
 #2, #4, #6  
 #7, #8, #9

006-0341  
 13/14†  
 (shown)  
 #2, #4, #6  
 #7, #8, #9

006-0342  
 15/16†  
 (shown)  
 #2, #4, #6  
 #7, #8, #9

006-0343  
 17/18  
 #2, #4, #6  
 #7, #8, #9

006-0344  
 9/10  
 Rigid  
 #2, #4, #6  
 #7, #8

006-0345    006-0346  
 11/12        11/12  
 Rigid        Extra Rigid  
 #2, #4, #6    #4, #6 #7,  
 #7, #8, #9    #8

006-0347    006-00348  
 13/14        13/14  
 Rigid        Extra Rigid  
 #2, #4, #6    #4, #6 #7,  
 #7, #8, #9    #8

006-0349  
 15/16  
 Rigid  
 #2, #4, #6  
 #7, #8, #9

006-0350  
 17/18  
 Rigid  
 #2, #4, #6  
 #7, #8, #9



**CURETTES**  
 Curetas

CURETTE INSTRUMENTS  
 HOLLOW HANDLE 8.5MM, LENGTH 170MM

CURETTE INSTRUMENTS  
 SOLID HANDLE 6MM, LENGTH 170MM

CURETTE INSTRUMENTS  
 SOLID HANDLE 6MM, LENGTH 170MM

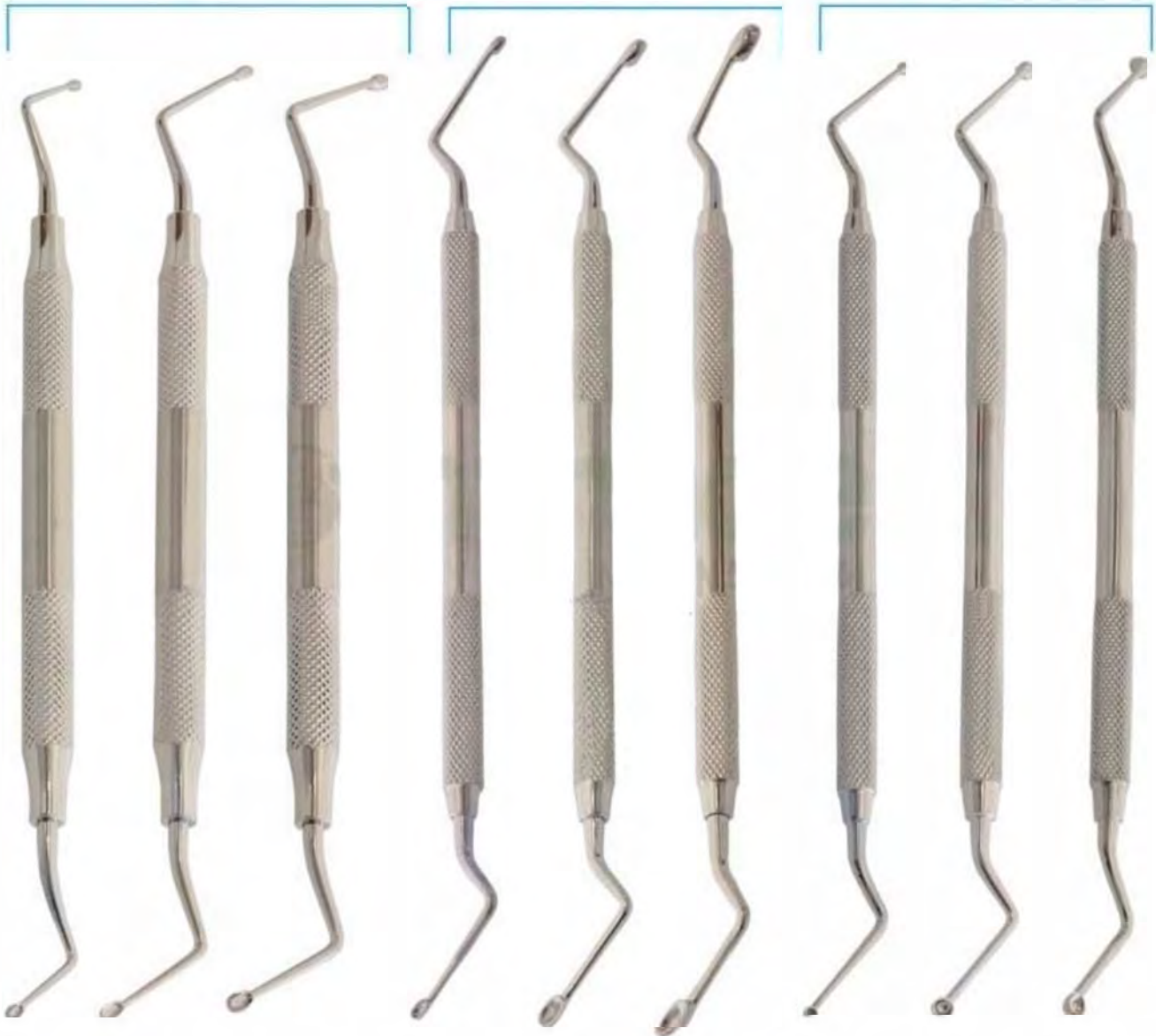

|           |           |           |           |           |           |           |           |           |
|-----------|-----------|-----------|-----------|-----------|-----------|-----------|-----------|-----------|
| 006-0351  | 006-0352  | 006-0353  | 006-0354  | 006-0355  | 006-0356  | 006-0357  | 006-0358  | 006-0359  |
| Hemingway | Hemingway | Hemingway | Hemingway | Hemingway | Hemingway | Hemingway | Hemingway | Hemingway |
| 2mm, 2mm  | 3mm, 3mm  | 4mm, 4mm  | 2mm, 2mm  | 3mm, 3mm  | 4mm, 4mm  | 2mm, 2mm  | 3mm, 3mm  | 4mm, 4mm  |



**EXCAVATORS**  
 Excavateurs

EXCAVATORS INSTRUMENTS SOLID HANDLE 6MM, LENGTH 170MM SPOONS





**EXCAVATORS**  
Excavateurs

OVAL SPOONS/DARBY-PERRY      EXCAVATORS INSTRUMENTS  
SOLID HANDLE 6MM, LENGTH 170MM      EXCAVATORS

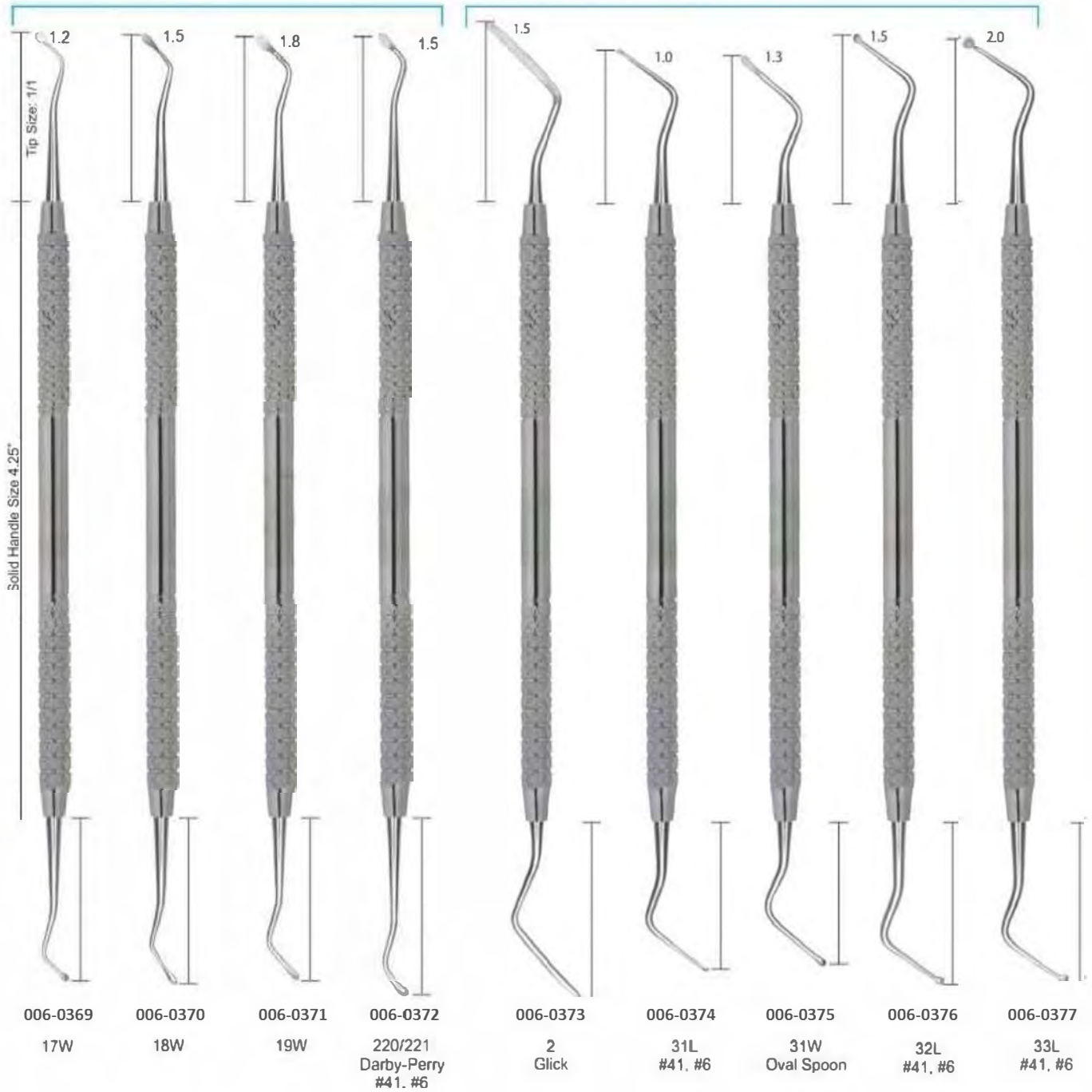



**EXCAVATORS**  
 Excavateurs

EXCAVATORS INSTRUMENTS  
 SOLID HANDLE 6MM, LENGTH 170MM

BLADES

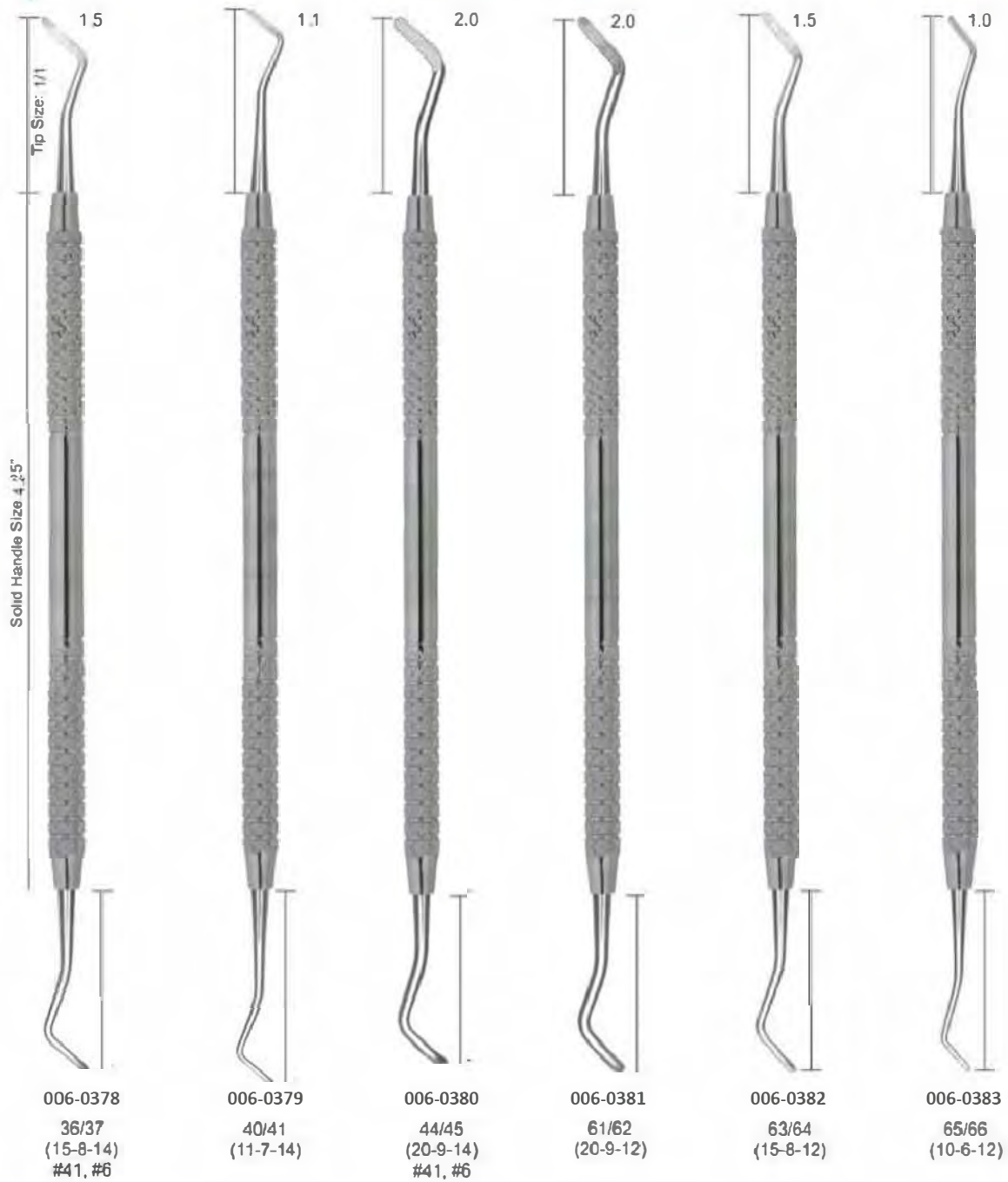



**EXCAVATORS**  
 Excavateurs

EXCAVATORS INSTRUMENTS SOLID HANDLE 6MM, LENGTH 170MM

ENGLISH PATTERNS

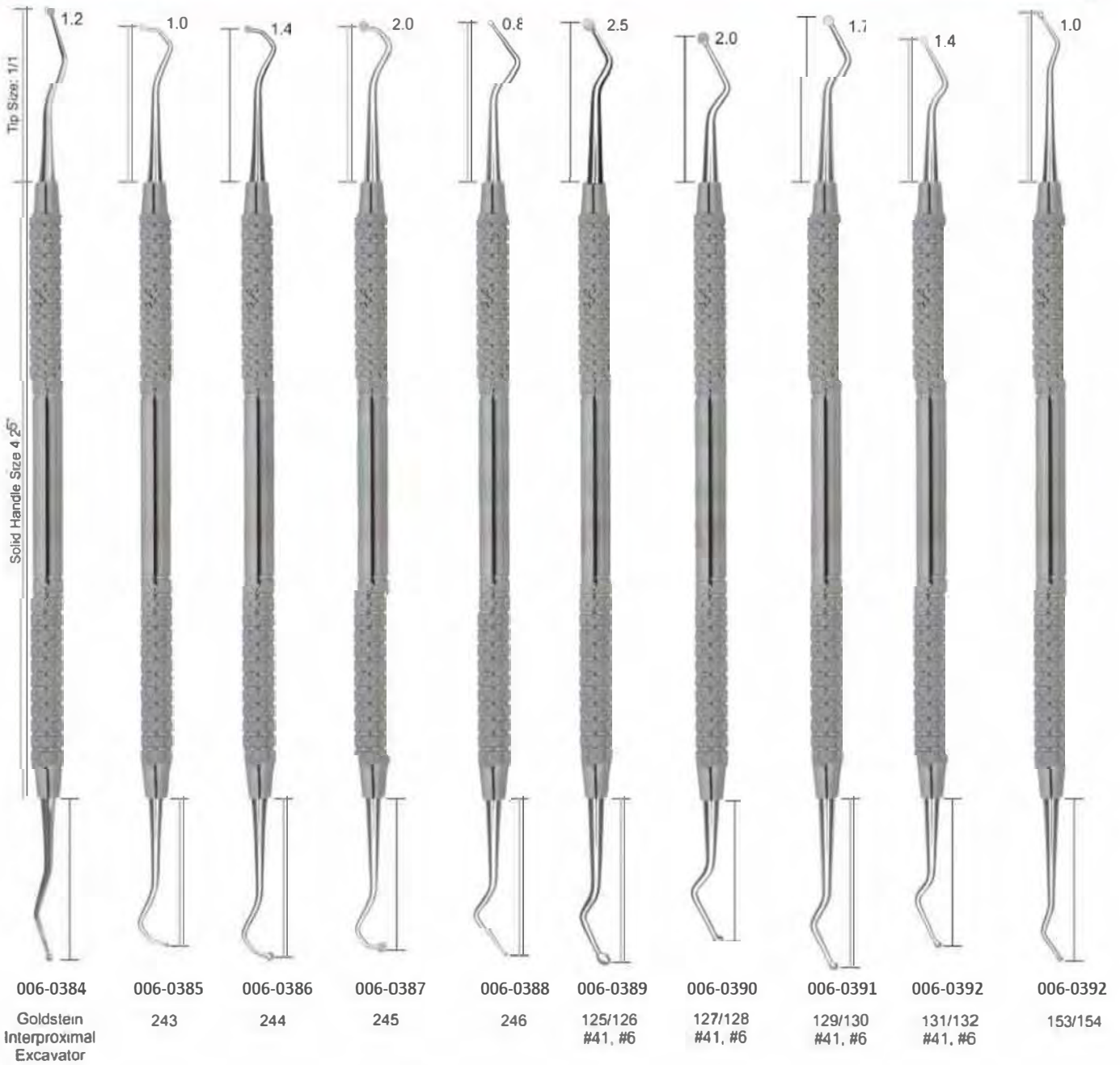



**FILLING INSTRUMENTS**  
**Strumenti Per Otturazioni**

**HATCHETS**

**RESTORATIVE INSTRUMENTS SOLID HANDLE 6MM, LENGTH 170MM**

|                                |                                |   |                                |   |
|--------------------------------|--------------------------------|---|--------------------------------|---|
| 006-0394<br>13/14<br>(20-9-14) | 006-0395<br>15/16<br>(15-8-14) | 006-0396<br>17/18<br>(10-6-14)<br>#41, #6 | 006-0397<br>51/52<br>(15-8-12) | 006-0398<br>53/54<br>(10-6-12)<br>#41, #6 |
|--------------------------------|--------------------------------|---|--------------------------------|---|

**ANTERIOR**

|  |                           |                           |                 |               |                         |                                     |                |                                     |
|--|---------------------------|---------------------------|-----------------|---------------|-------------------------|-------------------------------------|----------------|-------------------------------------|
| 006-0393<br>8/9H<br>(10-7-14)<br>#41, #6 | 006-0399<br>8A<br>#41, #6 | 006-0400<br>11<br>#41, #6 | 006-0401<br>179 | 006-0402<br>G | 006-0403<br>1/2<br>Trco | 006-0403A<br>Darby Perry<br>Trimmer | 006-0404<br>W1 | 006-0405<br>1<br>Woodson<br>#41, #6 |
|--|---------------------------|---------------------------|-----------------|---------------|-------------------------|-------------------------------------|----------------|-------------------------------------|





**FILLING INSTRUMENTS**  
 Strumenti Per Otturazioni

**CARVERS**

**RESTORATIVE INSTRUMENTS SOLID HANDLE 6MM, LENGTH 170MM**

Tip Size: 1/1  
 Solid Handle Size 4.25

006-0407  
 Inter-proximal  
 Off-Angle

006-0408  
 1/2-3  
 Hollenback  
 #41, #6  
 #7, #8

006-0409  
 3S  
 Hollenback  
 #41, #6, #7

006-0410  
 3  
 Hollenback

006-0411  
 8  
 Wiland  
 Minn.IPC1  
 #41, #6, #7

006-0406  
 8/9H  
 (10-7-14)  
 #41, #6

**TANNER**

006-0412  
 3  
 Tanner

006-0413  
 4  
 Tanner

006-0414  
 5  
 Tanner

006-0415  
 6  
 Tanner

**WALL**

006-0416  
 1  
 Wall

006-0417  
 3  
 Wall

**WARD**

006-0418  
 1  
 Ward

006-0419  
 2  
 Ward



**FILLING INSTRUMENTS**  
 Strumenti Per Otturazioni

**RESTORATIVE INSTRUMENTS**

**SOLID HANDLE 6MM, LENGTH 170MM**

|  |                   |              |                         |                   |               |   |                                       |          |
|--|-------------------|--------------|-------------------------|-------------------|---------------|---|---------------------------------------|----------|
| Tip Size: 1/1<br>Solid Handle Size 4.25" | <b>ANDREW</b>     |              | <b>CLAPPISON/FRAHAM</b> |                   |               | <b>HOLLENBACK</b>                       |                                       |          |
|  |                   |              |                         |                   |               |   |                                       |          |
|  | 006-0421          | 006-0422     | 006-0423                | 006-0424          | 006-0425      | 006-0426                                | 006-0427                              |          |
|  | 2 Andrew          | 3 Andrew     | 4 Clappison             | 2/3 Frahm #41, #6 | 104           | 1 Hollenback<br>2 Modified Cleoid Small | 1 Hollenbac<br>2 Modified Cleoid Larg |          |
|  | <b>HOLLENBACK</b> |              |                         |                   |               | <b>THARP</b>                            |                                       |          |
|  |                   |              |                         |                   |               |   |                                       |          |
|  | 006-0420          | 006-0428     | 006-0429                | 006-0430          | 006-0431      | 006-0432                                | 006-0433                              | 006-0434 |
|  | 1 Andrew          | 1 Hollenback | 2 Hollenback            | L7 Levy           | SHO-A Shoshan | 18 Sprengel                             | 1 Tharp                               | 2 Tharp  |



**FILLING INSTRUMENTS**  
 Strumenti Per Otturazioni

RESTORATIVE INSTRUMENTS SOLID HANDLE 6MM, LENGTH 170MM

**HOES**

Forming Line Angles on Anterior Preparations.

**CARVERS**

**AMALGAM FILES**



006-0436  
 Discoid-Cleoid  
 Carver

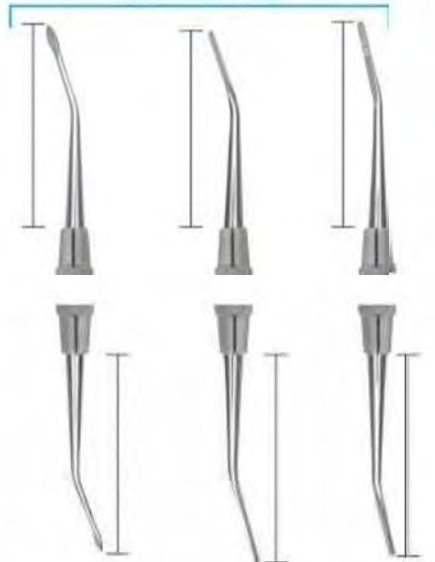

006-0437 31/32 Rhein  
 006-0438 1/4 Wedelstaedt  
 006-0439 2/5 Wedelstaedt

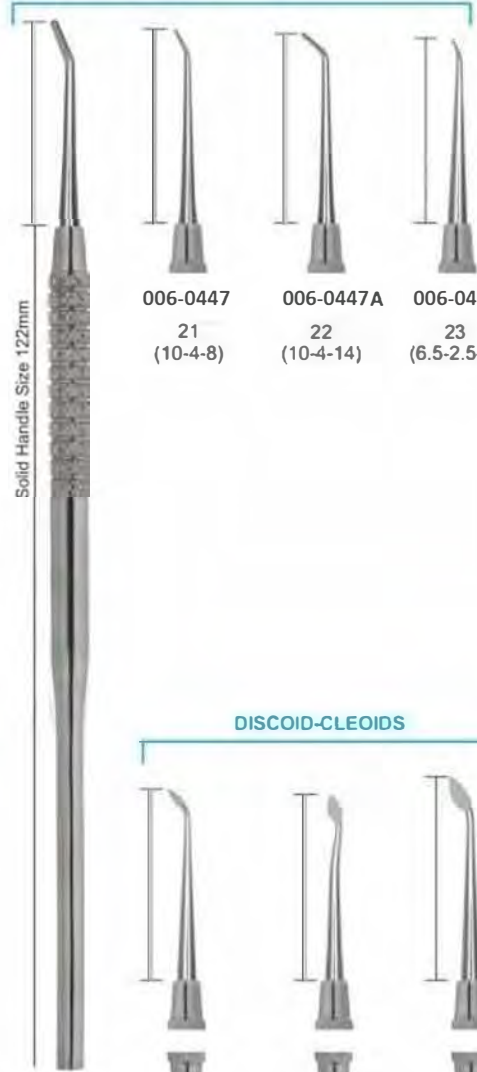

006-0447 21 (10-4-8)  
 006-0447A 22 (10-4-14)  
 006-0448 23 (6.5-2.5-9)

**DISCOID-CLEOIDS**

**DISCOID-CLEOIDS**

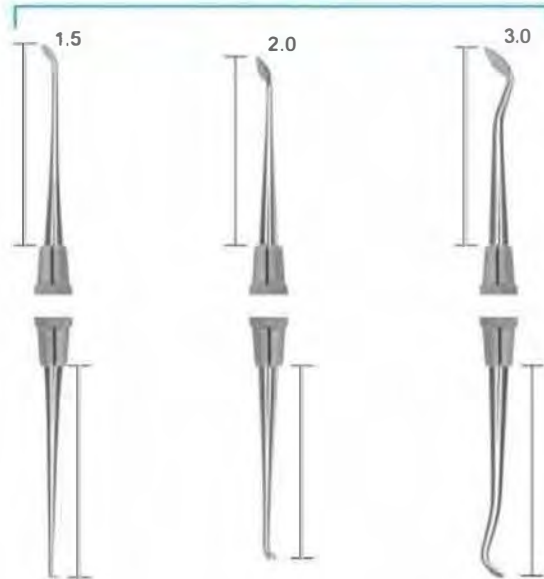

006-0440 1/2  
 006-0441 4/5 #41, #6, #7  
 006-0442 3/6 #41, #6, #7

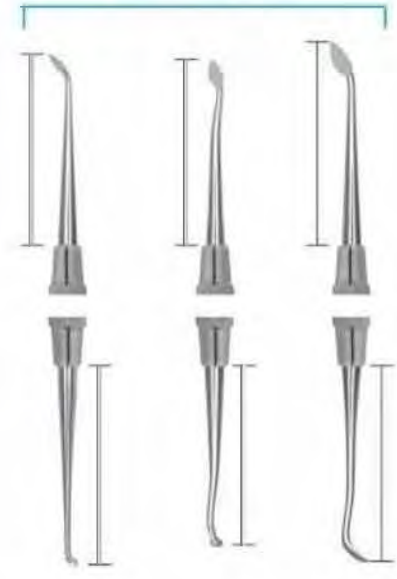

006-0443 20 (14-6-8)  
 006-0444 89/92 #41, #6, #7  
 006-0445 90B  
 006-0446 W-A-C-D

006-0435  
 Anatomical  
 Carver



**FILLING INSTRUMENTS**  
 Strumenti Per Otturazioni

**RESTORATIVE INSTRUMENTS**  
 SOLID HANDLE 6MM, LENGTH 170MM

**MARGIN TRIMMERS**

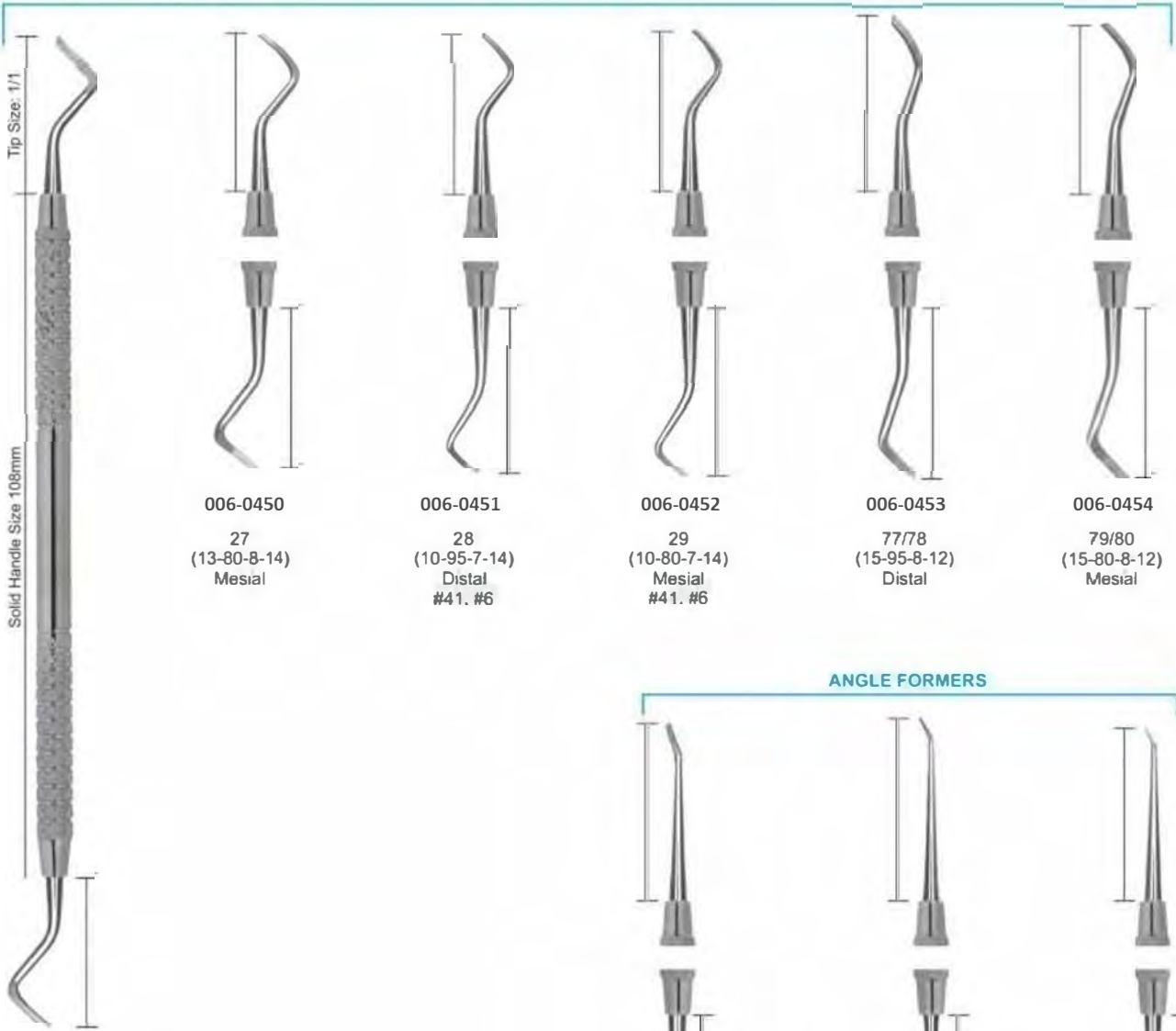

006-0450  
 27  
 (13-80-8-14)  
 Mesial

006-0451  
 28  
 (10-95-7-14)  
 Distal  
 #41, #6

006-0452  
 29  
 (10-80-7-14)  
 Mesial  
 #41, #6

006-0453  
 77/78  
 (15-95-8-12)  
 Distal

006-0454  
 79/80  
 (15-80-8-12)  
 Mesial

006-0449  
 26  
 (13-95-8-14)  
 Distal

**ANGLE FORMERS**

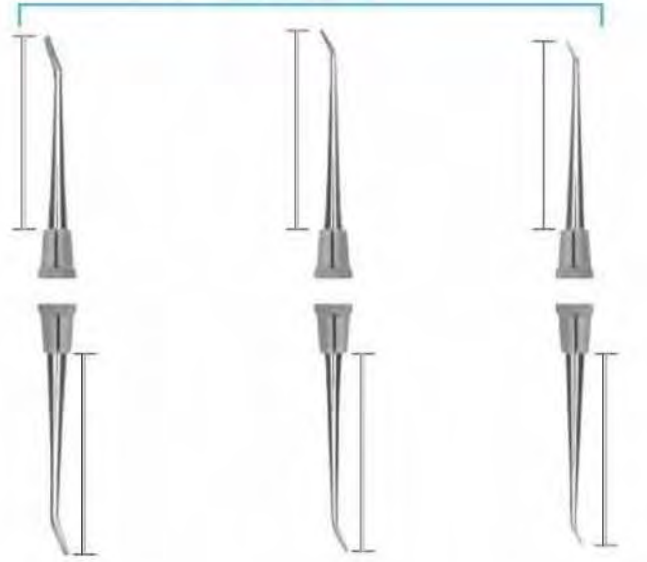

006-0455  
 30/31  
 (12-80-5-8)

006-0456  
 32/33  
 (9-80-4-8)

006-0457  
 34/35  
 (7-80-2.5-9)



**FILLING INSTRUMENTS**  
**Strumenti Per Otturazioni**

**P.K. THOMS WAXING INSTRUMENTS SOLID HANDLE 6MM, LENGTH 170MM**  
**P.K. THOMAS WAXING INSTRUMENTS**

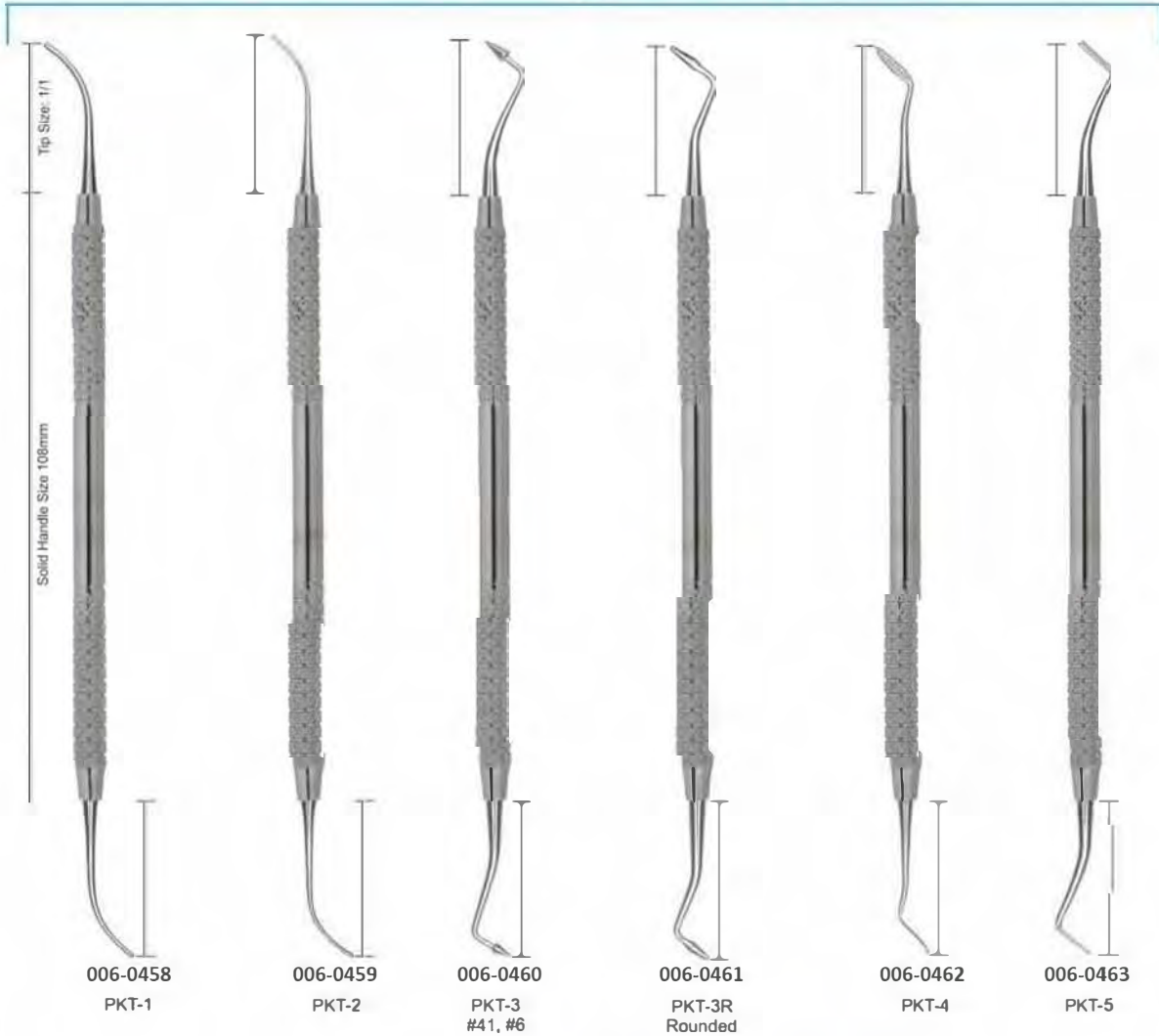

006-0464  
 P.k. Thomas Waxing  
 Instruments  
 Kit





**FILLING INSTRUMENTS**  
Strumenti Per Otturazioni

**Composite Gold Tip Instruments**



- 006-0465
- 006-0466
- 006-0467
- 006-0468
- 006-0469
- 006-0470
- 006-0471
- 006-0472
- 006-0473



**FILLING INSTRUMENTS**  
Strumenti Per Otturazioni

**Composite Gold Tip Instruments**





**FILLING INSTRUMENTS**  
**Strumenti Per Otturazioni**

**COMPOSITE INSTRUMENTS TITANIUM BLUE ENDODONTIC**

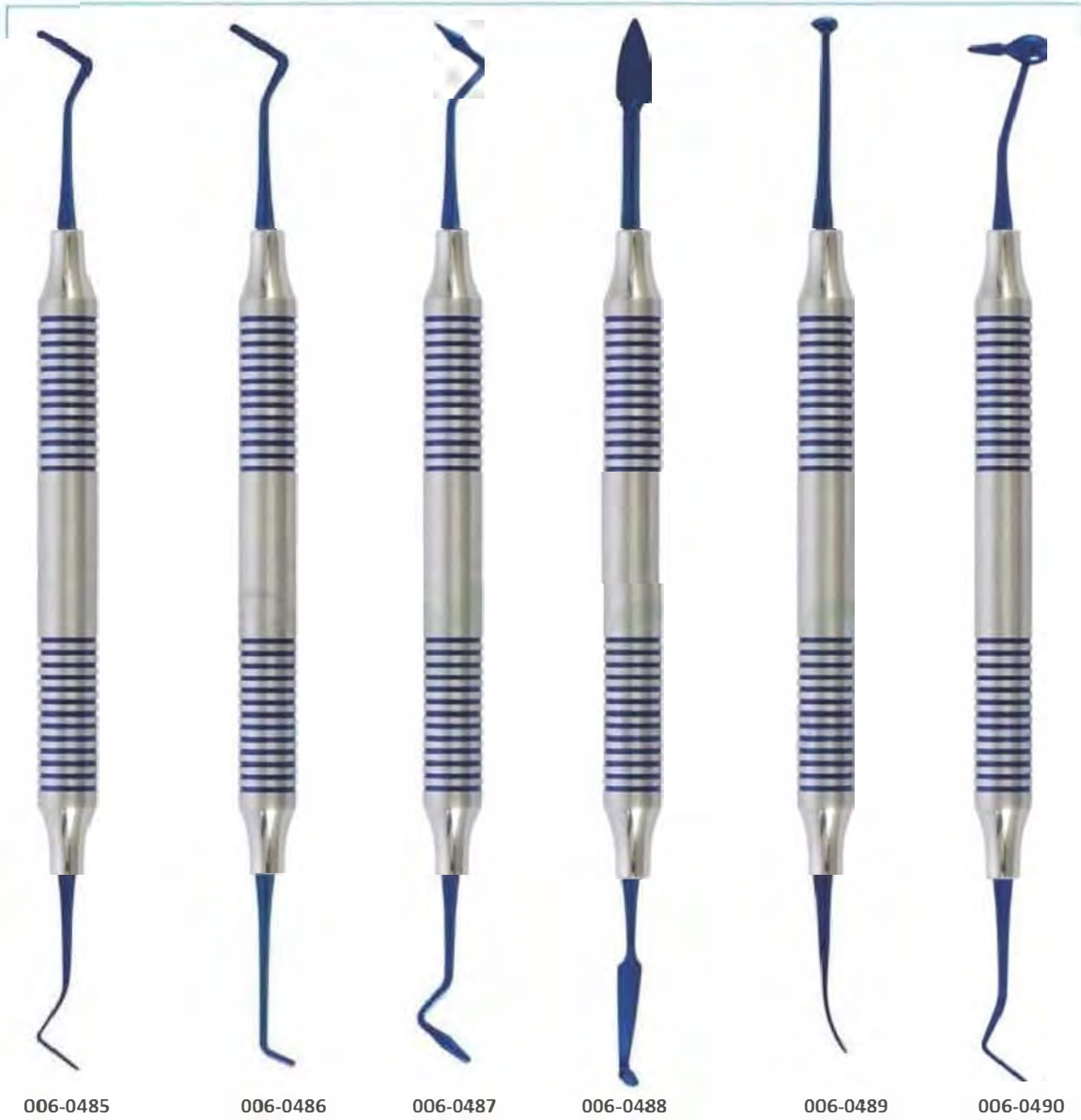

006-0491A  
 Composite Instruments Blue  
 Titanium with Cassettes





**X-Ray Stand**  
**Supporto Per Raggi X**



007-0490D

X Ray Film Hangers



007-0491B

X Ray Film Hangers



007-0492

X Ray Film Hangers



007-0493

X Ray Film Hangers



007-0494

X Ray Film Hangers



007-0495

X Ray Film Hangers



007-0496

X Ray Film Hanger



MCI-007-0497



MCI-007-0498



MCI-007-0499



007-0500

Dissecting Set  
 Set of 9 Pcs.  
 Set of 11 Pcs.



007-0501

Napkin Holder with  
 Plastic Chain



007-0502

Napkin holder with metal chain



007-0503  
 Mouth Props  
 Small

007-0504  
 Mouth Props  
 Medium

007-0505  
 Mouth Props  
 Large

**Key Rings**



007-0506



007-0507



007-0508



007-0509



007-0510



007-0511



**FILLING INSTRUMENTS**  
**Strumenti Per Otturazioni**

**CHISELS**

**HOES**





**FILLING INSTRUMENTS**  
Strumenti Per Otturazioni

**Composite Gold Tip Instruments**

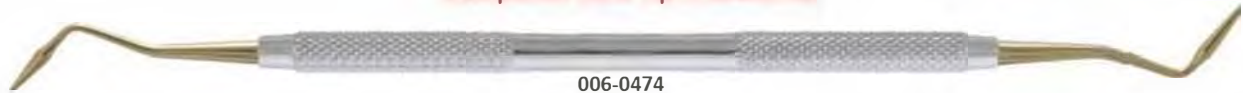

006-0474  
Markley 2

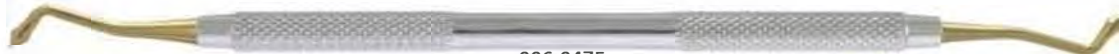

006-0475  
Westcott N 21



006-0476  
NYU/B2



006-0477  
Filling instruments



006-0478  
Ball Filling Instruments



006-0479  
Filling Instruments

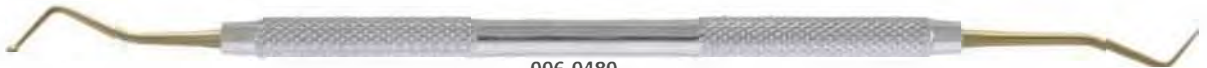

006-0480  
Filling Instruments



006-0481  
Filling Instruments

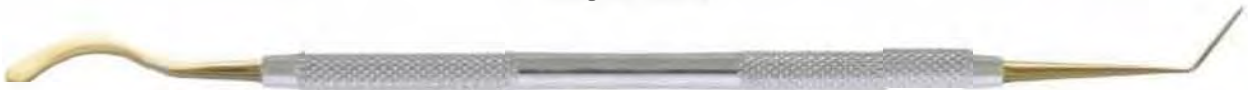

006-0482  
Plastic Filling Instruments



006-0483  
Heidemann



006-0484  
Plastic Filling Instruments



**WAX KNIVES**  
**Couteaux a Cire**



006-0542  
 Wooden Handle  
 Fig. 5  
 21.5 cm



006-0543  
 Wooden Handle  
 Fig. 7  
 19.5 cm curved



006-0544  
 Wooden Handle  
 Fig. 8  
 20 cm curved



006-0545  
 Wooden Handle  
 Fig. 9  
 22.5 cm curved



006-0546  
 Hook Knives



006-0547  
 Fig. 1  
 Lessmann  
 12.5 cm



006-0548  
 Fig. 2  
 Lessmann  
 17 cm



006-0549  
 Fig. 1  
 with small spoon  
 12.5 cm



006-0550  
 Fig. 2  
 with large spoon  
 17 cm



006-0551  
 Bacolite Handle  
 Wax Knives,  
 Small



006-0552  
 Bacolite Handle  
 Wax Knives,  
 Large



006-0553  
 Wooden Handle  
 Wax Knives,  
 Small



006-0554  
 Wooden Handle  
 Wax Knives,  
 Large



006-0555  
 Plaster Knife



006-0556  
 Fig. 1  
 17 cm



006-0556A  
 Fig. 3  
 16 cm



006-0557  
 Fig. 4  
 16 cm



006-0558  
 Special Inox  
 19.5 cm



**ARTICULATORS**  
 Artocilar



008-0559

**Technical Datas:**

|                                  |              |
|----------------------------------|--------------|
| Intercondylar distance           | 120 mm.      |
| condylar inclination             | fixed at 30° |
| Bennet angle                     | fixed at 7°  |
| Incisal table inclination        | 10°          |
| Distance between mounting plates | 85 mm.       |
| Weight                           | 400 gr.      |
| Opening (item 5000)              | 125°         |
| Opening (item 5010)              | 180°         |



008-0560

**Technical Datas:**

|                                  |             |
|----------------------------------|-------------|
| Intercondylar distance           | 110 mm.     |
| condylar inclination             | ixed at 30° |
| Bennet angle                     | fixed at 7° |
| Incisal table inclination        | flat        |
| Distance between mounting plates | 85 mm.      |
| Weight                           | 450 gr.     |
| Opening                          | 180°        |



008-0561

Stainless Steel Finishing  
 Royal Blue



008-0562



008-0563



008-0564



008-0565



008-0566



008-0567



008-0568



008-0569



008-0570



008-0571

**Nakawani**  
 Dental Laboratory  
 Instrument



### MAXILLOFACIAL SURGERY INSTRUMENTS

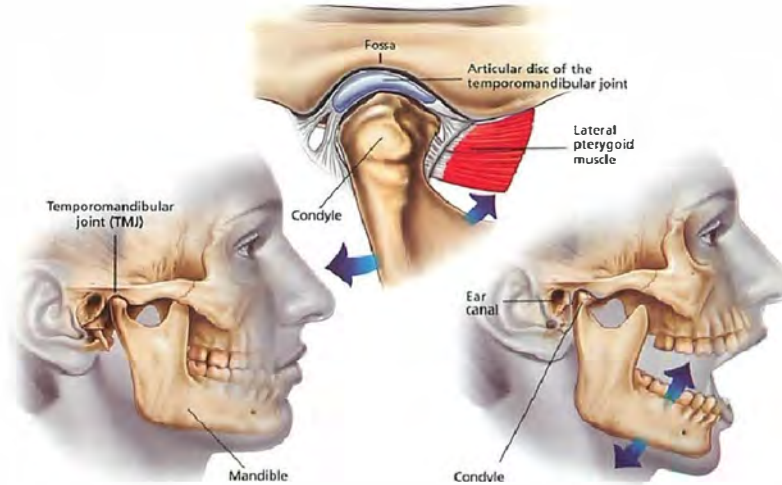



**RETRACTORS-MOUTH GAGS**  
 Ecarteurs-Ouvre-bouches



008-0572  
 Mouth Gag Molt  
 11 cm for (Children)



008-0573  
 Mouth Gag Molt  
 14 cm for (Adults)



008-0574 140 mm  
 006-0575 180 mm  
 Cheek Retractor



008-0576 140 mm  
 Cheek Retractor



008-0577  
 Wangen Holder,  
 vestibule  
 15 cm, with or without  
 lip protection.



008-0578  
 Wangen Holder,  
 vestibule 15 cm, with  
 or without lip protection,



008-0579  
 Wangen Holder  
 Wangen holder with dual  
 function, 17 cm.



Cheek Retractor



008-0580  
 140 mm



008-0581  
 150 mm



**RETRACTORS-MOUTH GAGS**  
**Ecarteurs-Ouvre-bouches**



008-0582 10.5cm  
 008-0583 13.5cm  
 Fig. 1  
 weilaner



008-0584 10.5cm  
 008-0585 13.5cm  
 Fig. 2  
 weilaner



008-0586  
 Stainless Steel  
 Double  
 Ended Cheek  
 Retractors



008-0587  
 Stainless Steel  
 Single  
 Ended Cheek  
 Retractors



Weitlander  
 008-0588 11cm  
 008-0589 13cm  
 008-0590 15cm



008-0594  
 Denhard  
 12 cm



008-0595  
 Roser-König  
 16 cm



008-0596  
 Roser-König  
 19 cm



008-0591 11cm  
 008-0592 13cm  
 008-0593 15cm  
 Jennings





**RETRACTORS**  
**Ecarteurs**

**Wound, Bendable**  
 Retractor, individually or as saving kit!



008-0597  
 Cheek Retractor  
 Long



008-0598  
 Cheek Retractor  
 Long



008-0599  
 Cheek Retractor  
 Long



008-0600 24 cm,  
 Retractor with  
**Ergo Grip**  
 ergonomic handle,



008-0601 20 cm,  
 Cheek Retractors,  
 Retractor Ivory  
 Width adjustable  
 & fixable.



008-0602 19 cm  
 Cheek Retractors,  
 tongue depressors



008-0603 16 cm  
 Cheek Retractors,  
 Minnesota



008-0604 20 cm  
 Cheek Retractors,  
 easy to bend  
 by hand,



008-0605 16 cm,  
 Cheek Retractors,  
 retractor and tongue  
 pushers BISHOP with  
 comfortable margin,



008-0606 25 cm,  
 Retractors Cheek  
 retractor combinator  
 Combination,



**RETRACTORS**  
 Ecarteurs



008-0607  
 Retractors, Unique  
 Length 175 mm,  
 angled 45 °



008-0608  
 Retractors, Unique  
 Length 175 mm,  
 angled 90°



008-0609  
 Retractors  
 16cm



008-0610  
 Retractors  
 19cm



008-0611  
 Retractors, Mini-Langenbeck  
 16 cm, hooks 22 mm.



008-0612  
 Retractors. Cheek  
 retractors combination  
 21 cm, 2



008-0613  
 Mini Retractor  
 about 8 cm,



008-0614  
 Retractors  
 17 cm, hooks 22 mm



**RETRACTORS**  
**Ecarteurs**



008-0615 30x16 mm,  
 surgically-flat,  
 21 cm. hook  
 Retractors, surgical-flat



008-0616 42x11 mm  
 surgically-flat,  
 21 cm. hook  
 Retractors, surgical-flat



008-0617 63x12 mm,  
 surgically-flat,  
 21 cm. hook  
 Retractors, surgical-flat



008-0618 30x16 mm,  
 006-0619 42x11 mm,  
 006-0620 63x12 mm,  
 surgically-flat,  
 21 cm. hook  
 Retractors, surgical-flat



008-0621 30x11 mm  
 006-0622 30x16 mm,  
 21 cm. hook  
 Retractors, Langenbeck



008-0623  
 Retractors  
 21 cm,



008-0624  
 (120 X 12mm  
 Set of 2 pices)  
 Farabeuf



008-0625  
 Retractor Seldin



008-0626  
 FELDMAN  
 RETRACTOR  
 5-1/2", 14cm



**GUM SCISSORS**

Ciseaux Gencives



009-0627, 115mm  
 Iris  
 Straight



009-0628, 115mm  
 Iris  
 Curved



009-0629, 130mm  
 Goldman-Fox  
 Saw edge, straight



009-0630, 130mm  
 Goldman-Fox  
 Saw edge, Curved



009-0631, 115mm  
 La Grange  
 Saw edge, double Curved



009-0632, 140mm  
 009-0633, 170mm  
 009-0634, 230mm  
 Mayo  
 Straight



009-0635, 140mm  
 009-0636, 170mm  
 009-0637, 230mm  
 Mayo  
 Curved



009-0638, 145mm  
 009-0638A, 160mm  
 009-0639, 180mm  
 009-0640, 200mm  
 Metzenbaum  
 Straight



009-0641, 145mm  
 009-0641A, 160mm  
 009-0642, 180mm  
 009-0643, 200mm  
 Metzenbaum  
 Curved



009-0644, 160mm  
 Kelly  
 Straight



009-0645, 160mm  
 Kelly  
 Curved



009-0646, 115mm  
 Iris  
 Straight



009-0647, 115mm  
 Iris  
 Curved



009-0648, 115mm  
 La Grange  
 Double Curved



009-0649, 130mm,  
 Straight  
 Goldman-Fox



009-0650, 130mm,  
 Curved  
 Goldman-Fox



009-0651, 160mm,  
 Curved  
 Kelly



009-0652, 115mm,  
 Straight  
 Iris



009-0653, 115mm,  
 Curved  
 Iris



009-0654, 90mm str  
 009-0654A, 90mm cvd  
 Micro Iris



**GUM SCISSORS**  
**Ciseaux Gencives**

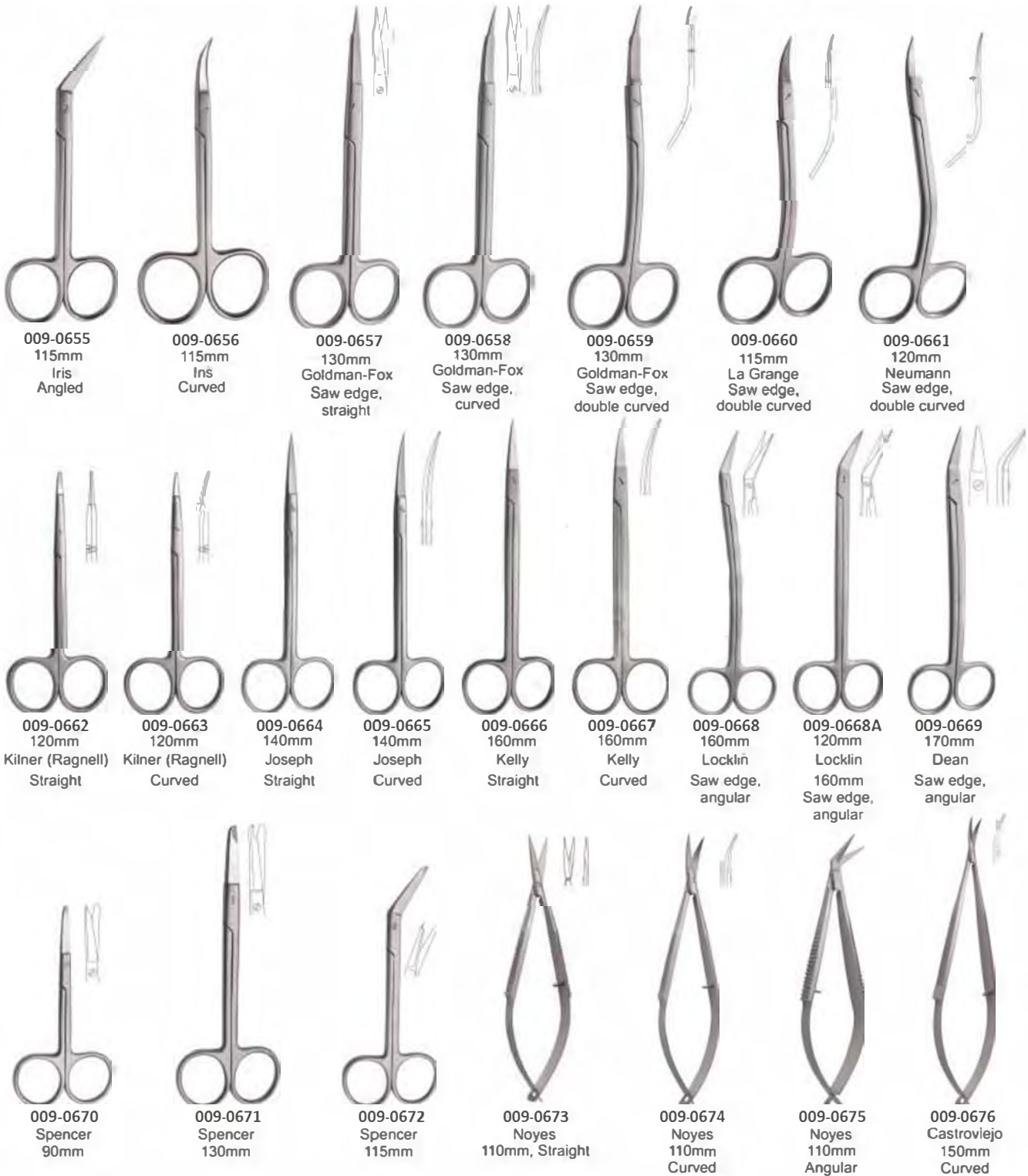



**SCISSORS & NEEDLE HOLDERS**  
 Porta eiguilles & Ciseaux



009-0677  
 130mm  
 Straight



009-0678 130mm 130mm  
 009-0679 160mm 160mm  
 009-0680 180mm 180mm  
 Mayo Mayo



009-0681 140mm 140mm  
 009-0682 200mm 200mm  
 Straight Curved  
 Mayo Mayo



009-0683 145mm straight  
 009-0683A 145mm curved  
 009-0684 200mm straight  
 009-0684A 200mm curved  
 Metzenbaum



009-0685  
 Beebee  
 110mm  
 Saw edge,  
 straight



009-0686  
 Beebee  
 110mm  
 Saw edge,  
 curved



009-0687  
 Beebee  
 110mm  
 Saw edge, straight



009-0688  
 Beebee  
 110mm  
 Saw edge, curved



009-0689  
 Universal  
 120mm  
 Saw edge



009-0690  
 Universal  
 120mm



010-0691 130mm  
 010-0692 150mm  
 010-0693 180mm  
 Crile



010-0694 130mm  
 Halsey



010-0695  
 Baumgartner  
 130mm



010-0696  
 Derf  
 120mm



010-0697  
 Delicate  
 150mm



010-0698 130mm  
 010-0699 160mm  
 010-0700 180mm  
 010-0701 200mm  
 Mayo-Hear



010-0702 150mm  
 straight  
 Crile-Wood



010-0703 150mm  
 curved  
 Crile-Wood



**NEEDLE HOLDERS**  
**Porte Aiguilles**



010-0704 130mm  
 010-0705 150mm  
 010-0706 180mm  
 Castroviejo



010-0707 130mm  
 Halsey



010-0708 130mm  
 Baumgartner



010-0709 120mm  
 Derf



010-0710 150mm  
 Delicate



010-0711 170mm  
 Adson



010-0712 130mm  
 010-0713 160mm  
 010-0714 180mm  
 010-0715 200mm  
 Mayo-Hegar



010-0716 150mm  
 Crile-Wood



010-0717 str 140mm cvd  
 010-0718 str 180mm cvd  
 Castroviejo



010-0719 140mm  
 Olsen-Hegar Needle  
 Holder With Scissors



010-0720 160mm  
 Gillies Needle  
 Holder With Scissors



010-0721 140mm  
 010-0722 170mm  
 Mathieu



010-0723 140mm str  
 010-0723A 140mm cvd  
 010-0723B 150mm str  
 010-0723C 150mm cvd  
 010-0724A 180mm str  
 010-0724 180mm cvd  
 Castroviejo



010-0725 140mm  
 Olsen-Hegar Needle  
 Holder With Scissors



010-0726 160mm  
 Gillies Needle  
 Holder With Scissors



010-0727 90mm str  
 010-0727A 90mm cvd  
 Hartmann (Baby  
 Mosquito)

































010-0727B 120mm str  
 010-0727D 120mm cvd  
 010-0728 125mm str  
 010-0728A 125mm cvd  
 Halstead Mosquito



**MICRO NEEDLE HOLDERS**  
**Micro Porta oghi Acciaio**



|  |   |   |   |   |  |
|--|---|---|---|---|--|
|  | 010-0729B<br> 150 mm   | 010-0730B<br> 150 mm   | 010-0731B<br> 150 mm   | 010-0732B<br> 150 mm  | <br>Castroviejo<br>150 mm                                |
|  | 010-0733B<br> 180 mm   | 010-0734B<br> 180 mm   | 010-0735B<br> 180 mm   | 010-0736B<br> 180 mm  | <br>Castroviejo<br>180 mm                                |
|  | <b>Needle holders stainless steel</b>   |   |   |   |  |
|  | 010-0737B<br> 140 mm   | 010-0738B<br> 140 mm   |   |   | <br>Castroviejo<br>5-0, 6-0, 7-0, 8-0, 9-0, 10-0         |
|  | 010-0739B<br> 140 mm | 010-0740B<br> 140 mm |   |   | <br>Castroviejo<br>5-0, 6-0, 7-0, 8-0, 9-0, 10-0, 11-0 |
|  | 010-0741B<br> 140 mm | 010-0742B<br> 140 mm |   |   | <br>Castroviejo<br>4-0, 5-0, 6-0                       |
|  |   | 010-0743B<br> 140 mm |   |   | <br>Castroviejo<br>5-0, 6-0, 7-0, 8-0, 9-0, 10-0, 11-0 |
|  |   | 010-0744B<br> 140 mm |   |   | <br>Castroviejo<br>5-0, 6-0, 7-0, 8-0, 9-0, 10-0, 11-0 |
|  |   | 010-0745B<br> 140 mm |   |   | <br>Castroviejo<br>4-0, 5-0, 6-0                       |
|  | 010-0746B<br> 180 mm | 010-0747B<br> 180 mm | 010-0748B<br> 180 mm | 010-0749B<br> 180 mm | <br>Castroviejo<br>5-0, 6-0, 7-0, 8-0, 9-0, 10-0, 11-0 |





**NEEDLE HOLDERS WITH TUNGSTEN CARBIDE INSERTS**  
 Porta aghi con riporti al carburo di tungsteno



125 mm 010-0750B

Derf  
 ~ 3-0, 4-0, 5-0



140 mm 010-0757B

Mathieu-Kocher  
 ~ 2-0, 3-0, 4-0

170 mm 010-0758B



130 mm 010-0751B

Halsey  
 ~ 3-0, 4-0, 5-0, 6-0



140 mm 010-0759B

Mathieu  
 ~ 2-0, 3-0, 4-0

170 mm 010-0760B



145 mm 010-0752B

Baumgartner  
 ~ 2-0, 3-0, 4-0



140 mm 010-0761B

Mathieu  
 ~ 2-0, 3-0, 4-0

170 mm 010-0762B



150 mm 010-0753B

Crilewood  
 ~ 3-0, 4-0, 5-0, 6-0



140 mm 010-0763B

Olsen-Hegar  
 ~ 3-0, 4-0, 5-0

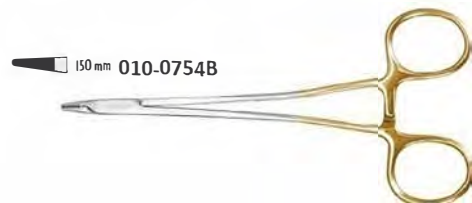

150 mm 010-0754B

Swedish-Micro Vascular  
 ~ 4-0, 5-0, 6-0

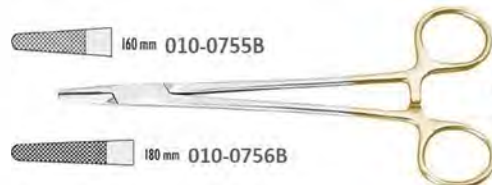

160 mm 010-0755B

Mayo-Hegar  
 ~ 2-0, 3-0, 4-0, 5-0



180 mm 010-0764B

Toennis  
 ~ 2-0, 3-0, 4-0

180 mm 010-0756B



**HAEMOSTATIC FORCEPS & TOWEL CLAMPS**  
**Pinces Hemostatiques, Pinces a Compresses**



010-0729 125mm str  
 010-0729A 125mm cvd  
 Halstead Mosquito 1x2



010-0730 140mm str  
 010-0730A 140mm cvd  
 Kelly



010-0731 140mm str  
 010-0731A 140mm cvd  
 010-0732 160mm str  
 010-0732A 160mm cvd  
 010-0733 180mm str  
 010-0733A 180mm cvd  
 010-0734 200mm str  
 010-0734A 200mm cvd  
 Rochester-Pean



010-0735 140mm str  
 010-0735A 140mm cvd  
 010-0736 160mm str  
 010-0736A 160mm cvd  
 010-0737 180mm str  
 010-0737A 180mm cvd  
 010-0738 200mm str  
 010-0738A 200mm cvd  
 Rochester-Kocher 1x2



010-0739 160mm str  
 010-0739A 160mm cvd  
 Kelly-Rankin



010-0740 100mm  
 010-0741 130mm  
 Lorna



010-0742 150mm  
 Allis-Baby 3:4



010-0743 200mm  
 Allis 4.5



010-0744 200mm  
 Allis 6:7



010-0745 140mm  
 Backhaus  
 Not-perforating and  
 not-damaging



010-0746 130mm  
 Backhaus



010-0747 90mm  
 Backhaus



010-0748 90mm  
 Jones

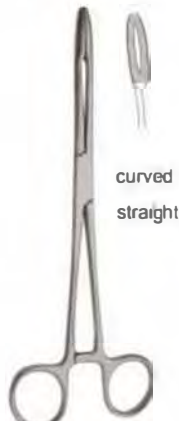

010-0749 200mm  
 Gross Maier  
 Dressing Forceps



010-0750 200mm  
 Foerster  
 Dressing Forceps



010-0751 70mm  
 Young  
 Tongue Forceps



010-0752 170mm  
 Collins  
 Tongue Forceps



**RUBBER DAM CLAMPS FORCEPS**  
**Pinces Porte-Crampons a Digue**

On request the Content of the rubber dam kit can be changed with other Instruments.

**Content:**

- 01 Anisworth
- 02 Brewer
- 03 Clamps Stand
- 04 Denture Plate
- 05 Rubber Dam Frame
- 06 Rubber Dam Box Lower Case
- 07 Rubber Dam Box Upper Case
- 08 Rubber Dam Clamp Fig. 212
- 09 Rubber Dam Clamp Fig. 211
- 10 Rubber Dam Clamp Fig. 8
- 11 Rubber Dam Clamp Fig. 8A
- 12 Rubber Dam Clamp Fig. 14
- 13 Rubber Dam Clamp Fig. 14A
- 14 Rubber Dam Clamp Fig. 0
- 15 Rubber Dam Clamp Fig. 00
- 16 Rubber Dam Clamp Fig. 2
- 17 Rubber Dam Clamp Fig. 2A
- 18 Rubber Dam Clamp Fig. 7



011-0753



011-0754  
 Small  
 Rubber Dam  
 Frame

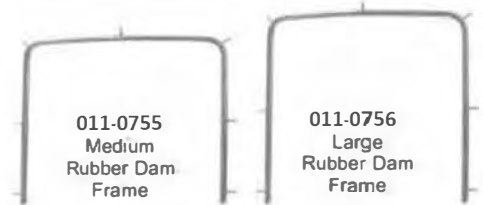

011-0755  
 Medium  
 Rubber Dam  
 Frame

011-0756  
 Large  
 Rubber Dam  
 Frame



011-757  
 Brewer



011-758  
 Stockes



011-0759  
 Palmer



011-0760  
 Ivory light weight



011-0761  
 Anisworth



011-0762  
 Anisworth



Punch Plier



011-0763  
 Anisworth



011-0764  
 Ivory



011-0765  
 Seaparating  
 Elastic Plier



**RUBBER DAM CLAMPS**  
**Crampons Pour Digue**



011-0766  
Fig. 15



011-0767  
Fig. 18



011-0768  
Fig. 24



011-0769  
Fig. 25



011-0770  
Fig. 26



011-0771  
Fig. 28



011-0772  
Fig. 30



011-0773  
Fig. 31



011-0774  
Fig. 51



011-0775  
Fig. 138



011-0776  
Fig. 139



011-0777  
Fig. 200



011-0778  
Fig. 201



011-0779  
Fig. 202



011-0780  
Fig. 203



011-0781  
Fig. 204



011-0782  
Fig. 205



011-0783  
Fig. 3



011-0784  
Fig. W3



011-0785  
Fig. 4



011-0786  
Fig. 56A



011-0787  
Fig. 7



011-0788  
Fig. 7A



011-0789  
Fig. 8



011-0790  
Fig. 8A



011-0791  
Fig. W8A



011-0792  
Fig. 10



011-0793  
Fig. 11



011-0794  
Fig. 12A



011-0795  
Fig. 13A



011-0796  
Fig. 14



011-0797  
Fig. 14A



011-0798  
Fig. 14AN



011-0799  
Fig. 22



011-0800  
Fig. 27



011-0801  
Fig. 207



011-0802  
Fig. 29



011-0803  
Fig. 206



011-0804  
Fig. 208



011-0805  
Fig. 209



011-0806  
Fig. 1



011-0807  
Fig. 1A



011-0808  
Fig. 2



011-0809  
Fig. 2A



011-0810  
Fig. W2A



011-0811  
Fig. 0



011-0812  
Fig. 00



011-0813  
Fig. 210



011-0814  
Fig. 211



011-0815  
Fig. 212



011-0816  
Fig. 6



011-0817  
Fig. 9



011-0818  
Fig. N06



011-0819  
Fig. U67



011-0818  
Fig. N06



011-0819  
Fig. U67



011-0820  
Fig. 214



011-0821  
Fig. P1



011-0822  
Fig. P2



011-0823  
Fig. G-1



011-0824  
Fig. G-2



**CROWN REMOVER**  
**Arrache-Couronnes**



012-0825  
 Crown Spreaders



012-0826  
 Mershon  
 14 cm  
 Band Pusher



012-0827  
 Fig. 0



012-0828  
 Manual Crown Removers  
 Handle with 3 tips



Only 3 tips



012-0829  
 Manual Crown Removers  
 Handle with 3 tips



Only 3 tips



012-0830  
 Manual Crown Remover



012-0831  
 Complete with 3 tips  
 and tightening keys

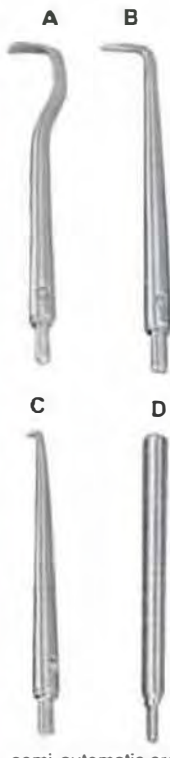

semi-automatic crown  
 & bridge remover

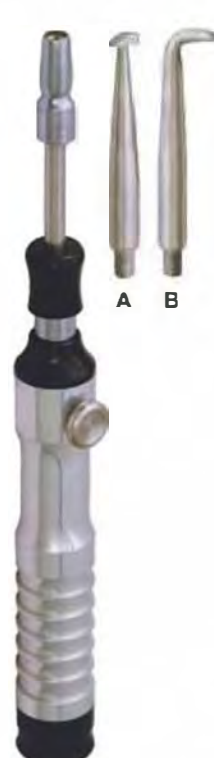

012-0832  
 semi-automatic Remover



012-0833  
 automatic Crown Remover

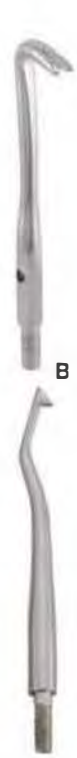

C



**MATRIX BANDS AND RETAINERS**  
 matrici e porta matrici



013-0834  
 Fig. 5  
 Ivory 8  
 5 cm



013-0835  
 Fig. 6  
 Ivory 8  
 6 cm



013-0836  
 Fig. 7  
 Ivory 8  
 7 cm



013-0837



013-0838  
 Siqveland  
 Narrow



Narrow  
 Wide



013-0839  
 5mm  
 with cheek protector



013-0840  
 Fig. 2  
 Tofflemire-Junier



013-0841  
 Fig. 3  
 Tofflemire-Senior



013-0842  
 Fig. 1  
 Tofflemire-Universal



013-0843  
 Narrow



013-0844  
 Wide

**Siqveland Retainers**



013-0845  
 Ivory 12



013-0846  
 Ivory 1



013-0847  
 Ivory



013-0848  
 Elliot



**AMALGAM CARRIERS**  
 spingi amalgama

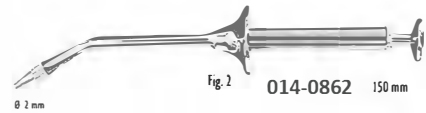

For micro filling



Amalgam well





**DISPOSABLE SCALPES SCALPEL BLADES AND HANDLES BLADE REMOVER**  
**Bisturi monouso lame per bisturi e manici togli lame**

**Scalpel blades**

Sterile  
 Individually packed  
 Box of 100 pieces

-  Fig. 10 015-0866
-  Fig. 11 015-0867
-  Fig. 12 015-0868
-  Fig. 12D 015-0869
-  Fig. 13 015-0870
-  Fig. 15 015-0871
-  Fig. 15C 015-0872
-  Fig. 20 015-0873
-  Fig. 21 015-0874
-  Fig. 22 015-0875
-  Fig. 23 015-0876
-  Fig. 24 015-0877
-  Fig. 25 015-0878

Ivory 12

Ivory 1

**Scalpel handles**

For scalpel blades no

10, 11, 12, 12D, 13, 15, 15C

-  Fig. 3 015-0879
-  Fig. 3G 015-0880
-  Fig. 5 015-0881
-  Fig. 5 015-0882
-  Fig. 5A 015-0883
-  Fig. 5S 015-0884
-  Fig. 7 015-0885
-  Fig. 7X 015-0886
-  Fig. 3L 015-0887

For blades no

: 20, 21, 22, 23, 24, 25

-  Fig. 4 015-0888

**Scalpels**

-  35 mm 015-0889
-  40 mm 015-0890
-  45 mm 015-0891
-  50 mm 015-0892

**Disposable scalpels**

-  Fig. 11 015-0894
  -  Fig. 15 015-0894
- Sterile, individually packed, box of 10 pieces

**Blade remover**

-  1. Hold blade as shown.
  -  2. Lift blade.
  -  3. Push forward to remove blade.
- 150 mm 015-0895
-  015-0896

Ivory

Elliot





**BONE INSTRUMENTS**  
**Strumenti ossivori**

**Chisels and gouges .**

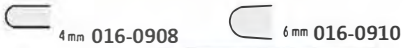

**Bone cutters**



**Mallets**

190 mm 016-0914



185 mm 016-0915



Spare plastic disks, pair



Spare plastic disks, pair



Lead filled head



185 mm 016-0919

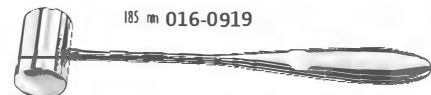



**PERIOTEEL INSTRUMENTS**  
 strumenti pour la parodontologie

**PERIOSTEEL ELEVATORS**



017-0920  
 BUSER



017-0921  
 Ohl 10



017-0922  
 Howard 9H



017-0923  
 Freer



017-0924  
 Freer 15



017-0925  
 Freer 16



017-0926  
 Molt 9



017-0927  
 Allen 9A



017-0928  
 Prichard 3



017-0929  
 Seldin 23



017-0930  
 Goldman-Fox  
 14



017-0931  
 P 24G



017-0932  
 Raspator, Raspatory  
 Length 175 mm,



017-0933  
 Raspator, Raspatory  
 Length 175 mm,



017-0934  
 Raspator, Raspatory  
 Length 175 mm,



017-0935  
 Raspator, Williger  
 Length 170 mm, different widths  
 (4 mm, 5 mm or 7 mm).



017-0936  
 Raspator, Williger  
 Length 170 mm, different widths  
 (4 mm, 5 mm or 7 mm).



017-0937  
 Raspator, Williger  
 Length 170 mm, different widths  
 (4 mm, 5 mm or 7 mm).



**ORTHODONTIC INSTRUMENTS**  
 strumenti orthodonticos

- |   |   |   |   |   |   |   |   |
|---|---|---|---|---|---|---|---|
|    |    |    |    |    |     |    |    |
| 017-0938<br>Aluminum Height Gauge 0.22  | 017-0939<br>Aluminum Height Gauge 0.18  | 017-0940<br>Height Gauge Movable  | 017-0941<br>Bone Bracket Gauge  | 017-0942<br>Endo Finger Ruler Span Measure Scale                                    | 017-0945<br>Compasso De Willis  | 017-0946<br>Bone Thickness Gauge 40mm, 180mm  | 017-0947<br>Osteometer Measuring Forceps  |
|   |   |   |   |   |   |   |   |
| 017-0948<br>Bracket Placer Tweezers (Extra Fine Tip)                                | 017-0949<br>Direct Bonding Bracket Holders 135mm                                    | 017-0950<br>Direct Bonding Bracket Holders 136mm                                    | 017-0951<br>Direct Bonding Bracket Holders 135mm                                    | 017-0952<br>Deluxe Bracket Holder   | 017-0953<br>Deluxe Bracket Holder Tweezers  | 017-0954<br>Deluxe Bracket Holder Tweezers  | 017-0955<br>Bracket Tweezer Slot Aligner  |
|  |  |  |  |  |  |  |  |
| 017-0956<br>Direct Bonding Bracket Holders 140mm                                    | 017-0957<br>Bracket Placing Tweezes   | 017-0958<br>Easy Access Tweezes   | 017-0959<br>Direct Bonding Bracket Holders 140mm                                    | 017-0960<br>Direct Bond Bracket Holder Tweezers Small Tip                           | 017-0961<br>Exact Bracket Holder Tweezers   | 017-0962<br>Easy Ecess Tweezers   | 017-0963<br>Slipper Tweezer   |



**ORTHODONTIC INSTRUMENTS**  
 strumenti orthodonticos

-   
 017-0964  
 Band sealer auto cleavable
-   
 017-0965  
 Ortho light scaler double ended
-   
 017-0966  
 Ortho light scaler double ended
-   
 017-0967  
 Ortho light scaler double ended
-   
 017-0968  
 Twiel-on elastic module instrument
-   
 017-0969  
 Twiel-on elastic module instrument
-   
 017-0970  
 Schure Band Seater
-   
 017-0971  
 Ortho light scaler
-   
 017-0972  
 Ortho light scaler
-   
 017-0973  
 Ortho light scaler heavy
-   
 017-0974  
 Ortho instrument
-   
 017-0975  
 Ortho instrument
-   
 017-0976  
 Ortho Light Band Pusher Scaler



**ORTHODONTIC INSTRUMENTS**  
 strumenti orthodonticos



017-0977  
 Ortho Light double ended  
 ligature director



017-0978  
 Ortho Light double ended  
 ligature director scaler



017-0979  
 Ortho Light double ended ligature scaler director tivate coil spring  
 are remove modules with one instruments

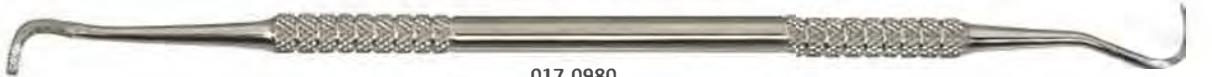

017-0980  
 Ortho band pusher scaler



017-0980A  
 Ortho Light Band Pusher Scaler



017-0981  
 Ortho ligature director single ended



017-0982  
 Ortho Light double ended ligature  
 director scaler



017-0983  
 Ortho Light double ended ligature scaler/director  
 tivate coil spring are remove modules with one instruments



017-0984  
 Ortho Light double ended ligature director



017-0985  
 Ortholite Ligature Director Scaler



017-0986  
 Ortho light ligature director double ended



017-0987  
 Double ended cement spatula



017-0988  
 Ortho light scaler single ended



pro  
**Selection**  
Made For  
**Experts**

**New**  
**OrthoClass**



**PLIERS FOR ORTHODONTICS & PROSTHETICS**  
 pinces pour l'orthodontie et la prothèse

**Band removers curved, left and right**  
 Curved tips provide easy access and grip of band without excess retraction of cheek or lips  
 Curved tips securely catches edge of band without slippage while pad rests on occlusal surface  
 Curved and heavy tips easily remove even stubborn bands



**018-0991**  
 Band removing pliers, left



**018-0994**  
 Band removing pliers, right



**018-0997**  
 Band seating pliers



**Bracket removing with plastic tip**  
 Safely and quickly removes D.B. brackets, soft pad rest on incisal/occlusal surface of tooth for leverage and is comfortable for patient, sharp tip wedge the bracket base, one squeeze easily remove the bracket without extra force



**018-0989**  
 Band removing pliers, long



**Bracket removing pliers**  
 Tips wedge between both edges of the bracket base and tooth surface to remove bracket easily.



**018-0995**  
 Bracket removing pliers angled  
 The 60° angled tip allows easy access to posterior brackets



**018-0998**  
 Bracket removing pliers straight



**Band removing pliers**  
 Safely and quickly removes posterior bands. Pad rests on occlusal surface and tip catches edge of band.



**018-0990**  
 Band removing pliers, long



**018-0992**  
 Replacement pads 4.8 mm (1/4"), 2 piece  
**018-0993**  
 Replacement pads 6.3 mm (3/16"), 2 pieces



**018-0996**  
 Contouring pliers  
 for contouring and adapting bands or crowns



**018-0999**  
 Contouring pliers  
 One convex and one concave tip for contouring and adapting bands crowns



**PLIERS FOR ORTHODONTICS & PROSTHETICS**  
pinces pour l'orthodontie et la prothese

Rectangular arch forming and torquing pliers  
(Ribbon arch pliers)  
Used to form offset and 90° bends on round or rectangular wire. Radiuses on tips edges do not score wire during torquing. Available in three different tip widths, tips are parallel at 0.5 mm opening.

Surgical ball hook crimping pliers  
Used to crimp surgical ball hooks to arch wire, slotted tip fits over the base of hook for secure hold while crimping, also can be used to crimp stops and posts. Long handles for easy access to posterior region



Urno light scaler single ended





**PLIERS FOR ORTHODONTICS & PROSTHETICS**  
 pinces pour l'orthodontie et la prothese



**018-1012**  
 Standard  
 Soft wire and ligature cutter. Standard  
 Fitted with un-breakable, corrosion  
 resistant and durable stainless steel tips



**018-1013**  
 Hard wire cutter, 15° angled



**018-1014**  
 Soft wire and ligature cutter, 45° angled  
 Fitted with un-breakable, corrosion resistant and  
 durable stainless steel tips



**018-1015**  
 Soft wire and ligature cutter, Micro



**018-1016**  
 Soft wire and ligature cutter, Mini



**Distal end cutters with safety hold**

- Falcon distal end cutters produce cleaner and closer cut than any other distal end cutter available in market
- Mini head offers easy access and better visibility
- Long handles give better control and leverage to user
- fitted with un-breakable, corrosion resistant and durable stainless steel tips



**018-1017**  
 Distal end cutter with safety hold, micro head



**018-1018**  
 Distal end cutter with safety hold,  
 mini head, long handles



**018-1019**  
 Distal end cutter with safety hold, mini head, long off-set  
 handles give better control, leverage and visibility to user



**018-1020**  
 Distal end cutter with safety hold,  
 mini head, long handles





**PLIERS FOR ORTHODONTICS & PROSTHETICS**  
 pinces pour l'orthodontie et la prothese



Multipurpose pliers, useful for placement and removal of archwires and auxiliaries. Tips are serrated to securely hold wire, the jaws are bowed and contact only at tips to prevent lip pinching, box joint design for stability.



Standard



018-1023  
Angled



018-1024  
Straight

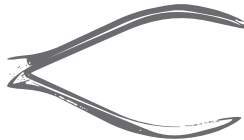

018-1027  
Light wire bending pliers  
Serrated tips and grooves assure accurate bending and closing of loops



018-1028  
Loop forming pliers



Omega



018-1030  
Loop forming pliers with replaceable 440 stainless steel tip, three step tip has 1.14, 1.52 and 1.91mm diameters



How Standard  
4mm wide tips



018-1021  
Angled



018-1022  
Straight



Mini  
2.4 mm wide tips



018-1025  
Angled



018-1026



018-1029  
Loop forming pliers  
Four steps beak for making precision loops of 3.45 or 6mm in round or rectangular wires. One tip is serrated to prevent wire slippage



**PLIERS FOR ORTHODONTICS & PROSTHETICS**  
 pinces pour l'orthodontie et la prothese

Utility pliers



Multipurpose pliers, useful for placement and removal of archwires and auxiliaries. Tips are serrated to securely hold wire and tapered thus fits between brackets. The jaws are bowed and contact only at tips to prevent lip pinching. Box joint design for stability.

with tungsten carbide inserts



**Angel**  
**018-1033**  
 Bird beak lab. pliers  
 Tips parallel at 1mm opening



**018-1031**  
 Weingart Mini  
 Slim design for better accessibility  
 in posterior and lingual areas



**018-1032**  
 Weingart



**018-1035**  
 Weingart Mini  
 Slim design for better accessibility  
 in posterior and lingual areas



**018-1036**  
 Weingart Narrow  
 Narrow long tips for better access to hard to reach areas



**Angel**  
**018-1037**  
 Round nose wire bending and  
 loop forming pliers



**Tweed**  
**018-1034**  
 Loop forming pliers



**Tweed**  
**018-1038**  
 Loop forming pliers with replaceable  
 440 stainless steel tip, three step tip has 1.34, 1.52 and  
 1.91mm diameters



**018-1039**  
 Replacement tip stainless steel 440  
 for Omega or Tweed loop forming pliers.  
 Tip diameters 1.14mm, 1.52 and 1.91mm



**018-1040**  
 Flat nose wire bending pliers



**Peeso**  
**018-1041**  
 Round nose wire bending pliers



**Weingart**  
**018-1042**  
 Slim and sleek design with long handles  
 for better access to the posterior area,  
 also suitable for lingual technique.



**018-1043**  
 Round nose wire bending and  
 loop forming pliers



**Peeso**  
**018-1044**  
 Crown and collar contouring pliers



**PLIERS FOR ORTHODONTICS & PROSTHETICS**  
**pinces pour l'orthodontie et la prothese**

**Adams wire bending pliers**  
 Tips of all Adams pliers parallel at 1mm opening  
 box joint, available in mini and maxi sizes

Adams pliers with tungsten carbide tips

**Aderer 3-Jaw wire bending pliers**  
 Precision aligned and contoured tips for  
 consistent bends without damaging wire.



**018-1045**

Adams Maxi Fig. 64



**018-1046**

Adams Maxi Fig. 65



Schwarz Midi

**018-1047**

Optical style, round and concave beaks  
 Loop forming pliers



Aderer - Maxi

**018-1048**



Schwarz Maxi

**018-1049**

Optical style, round and concave beak  
 Loop forming pliers



Aderer - Midi

**018-1050**



Adams Mini

**018-1051**



Adams Mini

**018-1052**



Aderer - Mini

**018-1053**



Adams Maxi Fig. 64

**018-1054**

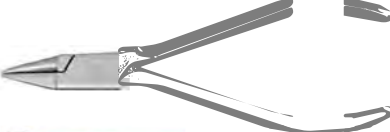

Adams Maxi Fig. 65

**018-1055**



Schwarz Mini

**018-1056**

Optical style, round and concave beaks.  
 Loop forming pliers



**PLIERS FOR ORTHODONTICS & PROSTHETICS**  
 pinces pour l'orthodontie et la prothese

Hard wire cutters  
 With durable hard metal inserts, stainless steel, autoclavable



Universal Mini - Dolphin style  
 018-1057

Wire bending and cutting pliers



Side cutter  
 018-1058



End cutter  
 018-1059

Hard wire cutters  
 Stainless steel, autoclavable



Universal - Dolphin style  
 018-1060

Wire bending and cutting pliers



Side cutter  
 018-1061



End Cutter  
 018-1062



Universal - Taper style  
 018-1063

Wire bending and cutting pliers

Heavy duty hard wire cutters  
 Compound action  
 Cut heavy wires with little force



Small  
 018-1064

Stainless steel, autoclavable



Small  
 018-1065

Stainless Steel, autoclavable



Waldsachs  
 018-1066

Wire bending and cutting pliers



Large  
 018-1067

Stainless steel, autoclavable



**PLIERS FOR ORTHODONTICS & PROSTHETICS**  
 pinces pour l'orthodontie et la prothese

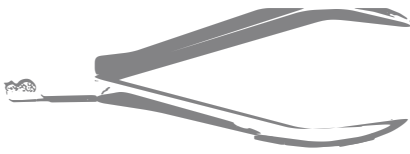

**Aderer**  
**018-1068**  
 Facebow loop forming pliers  
 For forming loops in either  
 inner or outer bows of facebow



**Schwarz graduated**  
**018-1069**  
 Optical style, round and concave beaks.  
 Loop forming pliers. Graduation prevents  
 wire slippage



**Mckellops**  
**018-1070**  
 Optical style, round and concave beaks.  
 Heavy loop forming pliers



**Magnum**  
**018-1071**  
 Universal facebow loop forming and cutting pliers  
 Heavy duty pliers easily bends or  
 cuts outer or inner bow of a facebow



**Young**  
**018-1072**  
 Loop forming pliers



**Nonce**  
**018-1074**  
 Adams class forming pliers

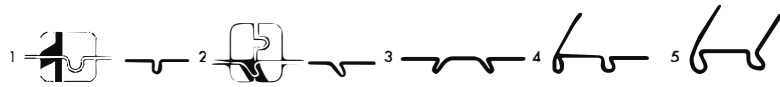

**Universal**  
**018-1073**  
 Parallel jaw pliers with side cutter, compound action  
 Powerful pliers easily cuts outer bow  
 of a facebow, serrated jaws assure  
 non-slip grip while bending



**Schwarz**  
**018-1075**  
 Arrow clasp forming pliers



**Schwarz**  
**018-1076**  
 Arrow clasp bending pliers





**PLIERS FOR ORTHODONTICS & PROSTHETICS**  
**pinces pour l'orthodontie et la prothese**

Bracket removing pliers angled



018-1087

Bracket removing pliers straight



018-1090

Bracket removing pliers with plastic tip



018-1093

Adhesive removing pliers



018-1096

Standard distal end cutter with safety hold  
 Fitted with un-breakable, corrosion resistant and durable stainless steel tips



018-1088

Mini head distal end cutter with safety hold  
 Fitted with un-breakable, corrosion resistant and durable stainless steel tips



018-1091

Distal end cutter with safety hold, mini head, long handles  
 Fitted with un-breakable, corrosion resistant and durable stainless steel tips



018-1094

Flush-cut distal end cutter with safety hold  
 Fitted with un-breakable, corrosion resistant and durable stainless steel tips



018-1097

Soft wire and ligature cutter, Mini  
 Fitted with un-breakable, corrosion resistant and durable stainless steel tips



018-1089

Soft wire and ligature cutter, standard  
 Fitted with un-breakable, corrosion resistant and durable stainless steel tips



018-1092

Soft wire and ligature cutter, 15° angled  
 Fitted with un-breakable, corrosion resistant and durable stainless steel tips



018-1095

Soft wire and ligature cutter, 45° angled  
 Fitted with un-breakable, corrosion resistant and durable stainless steel tips



018-1098



**PLIERS FOR ORTHODONTICS & PROSTHETICS**  
**pinces pour l'orthodontie et la prothese**

Loop forming pliers with cutter



Tweed  
 018-1099

Light wire bending pliers



Jorabok  
 018-1100

Rectangular arch forming and torquing pliers



Tweed / angel  
 018-1101

Surgical ball hook crimping pliers, angled



018-1102

Torquing pliers set



018-1103

Surgical ball hook crimping pliers, straight



018-1104

Loop forming pliers



Nance  
 018-1105

Detailing step pliers / Bayonet bending pliers - 1mm



018-1106

Stop pliers V-Bend - 1mm

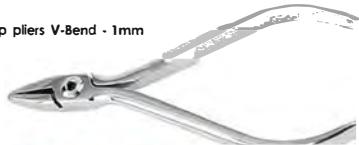

018-1107

Lingual / palatal arch forming pliers



018-1108

Archwire forming pliers, concave and convex tips



Hollow-Chop  
 018-1109

Multi-purpose pliers, bird beak, De la rosa and cutter in one



018-1110

Distal end bending pliers



Cinch back/ tie back)  
 018-1111

Distal end bending pliers



Hammer head  
 018-1112

Ligature forming pliers



018-1113

3-jaw wire bending pliers



Aclerer  
 018-1114





**IMPLANTOLOGY**  
 Implantologie

**IMPLANT GAGES**



019-1115

**Multifunctional Meter**  
 Length 90 mm,  
 different sizes,  
 8-10-11mm,  
 corrosion-resistant

019-1116

**Multifunctional Meter**  
 Length 90 mm,  
 different sizes,  
 5-13-15-17 mm,  
 corrosion-resistant

019-1117

019-1118

**Measuring Probe**  
 Length 170 mm  
 hand shape or flexible  
 (6-8-10-14-16 mm),  
 corrosion-resistant

019-1119

019-1120

019-1121

019-1122

**IMPLANT GAGES**

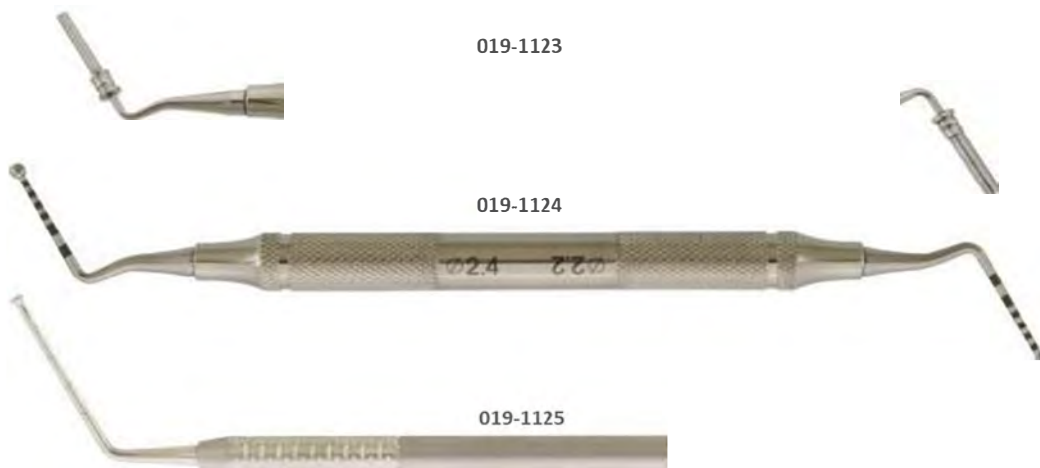

019-1123

019-1124

019-1125



**IMPLANTOLOGY**  
 Implantologie



**020-1126**  
 Clamp, Osteometer  
 Length about 155 mm,  
 edge width measurement,  
 two-sided scale,  
 measuring  
 range 0 - 25 mm



**020-1127**  
 Measuring Loop  
 straight length 90 mm,  
 measuring range  
 0 - 40 mm.



**020-1128**  
 Measuring Loop  
 angled length 90 mm,  
 measuring range  
 0 - 40 mm.



**020-1129**  
 Measuring loop, Castroviejo  
 angled, length 175 mm,  
 measuring range 0 - 40 mm,  
 with window



**020-1130**  
 Boley Gauge  
 Stainless Steel



**020-1130A**  
 Boley Gauge  
 Stainless Steel



**020-1131**  
 Measuring Loop  
 angled, length  
 175 mm,  
 measuring range  
 0 - 40 mm,



**020-1132**  
 Measuring Loop  
 straight length  
 175 mm,  
 measuring range  
 0 - 40 mm,



**020-1133**  
 Fig. 1  
 Iwanson  
 spring caliper  
 For metal and  
 porcelain



**020-1134**  
 Fig 2  
 Iwanson  
 spring caliper  
 For wax.



**020-1135**  
 Bone Thickness Gauge  
 40mm, 180mm



**020-1136**  
 Gauge  
 for measuring  
 distances  
 (0 - 90 mm).



**IMPLANTOLOGY**  
 Implantologie

**BLACK TITANIUM COLOUR COATED INSTRUMENTS**

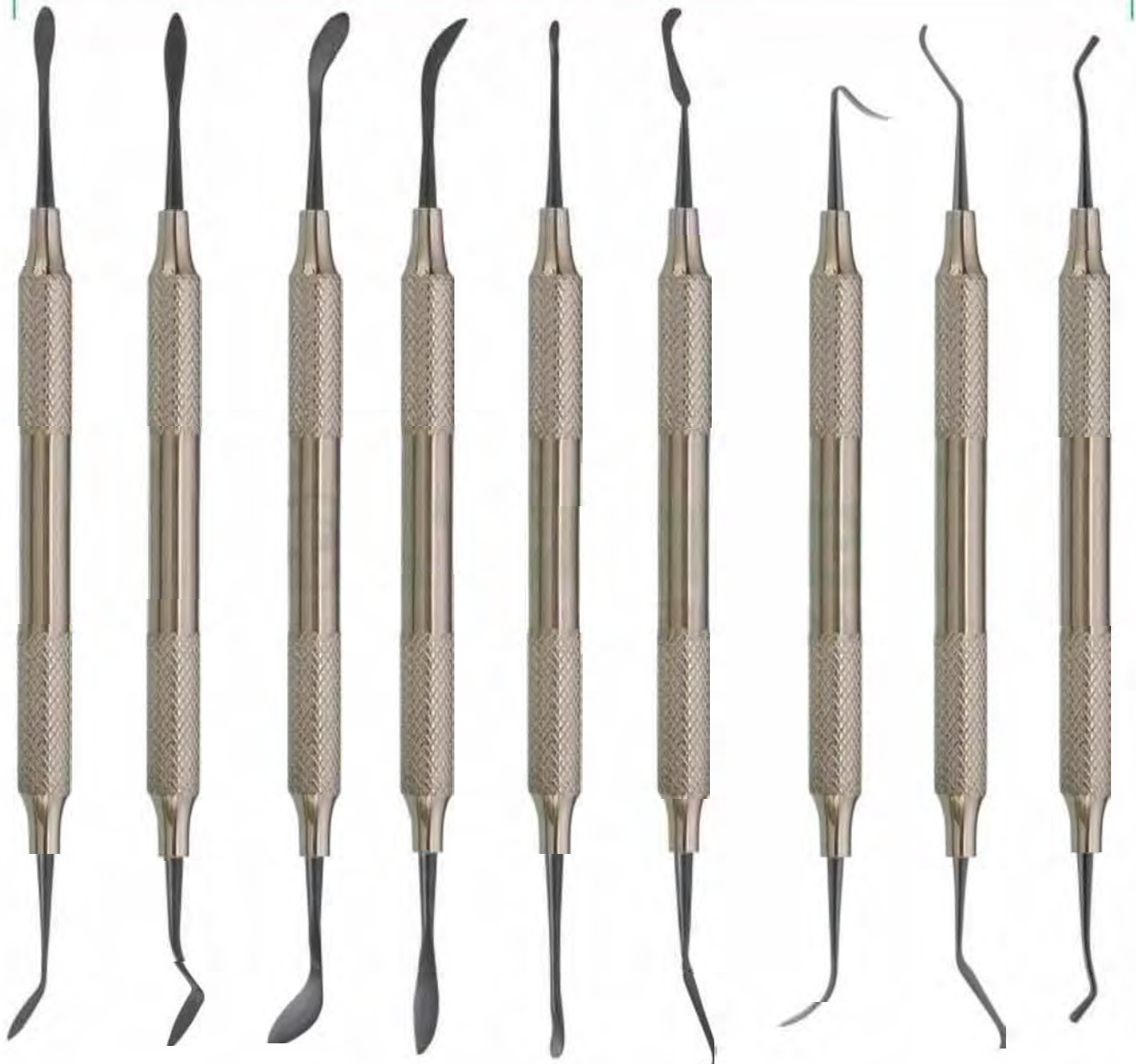

021-1164

A  
 Cosmetic  
 Contouring

021-1165

B  
 Cosmetic  
 Contouring

021-1166

C  
 Cosmetic  
 Contouring

021-1167

D  
 Cosmetic  
 Contouring

021-1168

E  
 Cosmetic  
 Contouring

021-1169

F  
 Cosmetic  
 Contouring

021-1170

Marginal Ridge  
 & Embrasure  
 Shaping Instrument

021-1171

Occlusal  
 Anatomy  
 Instrument

021-1172

Composite  
 Packing  
 Instrument



**IMPLANTOLOGY**  
 Implantologie

BLACK TITANIUM COLOUR COATED INSTRUMENTS

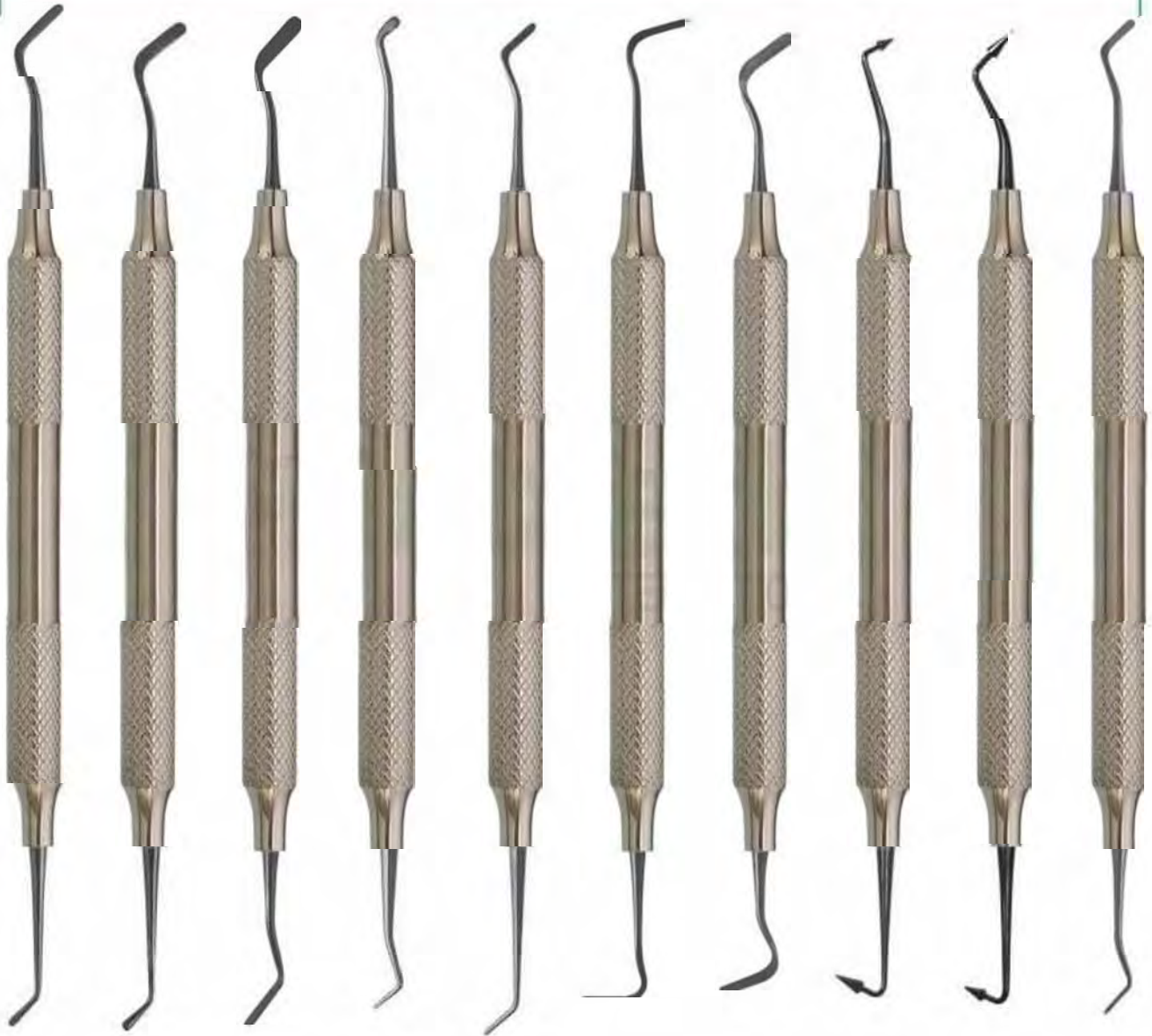

- |          |          |                  |            |          |                      |                  |                  |                  |                      |
|----------|----------|------------------|------------|----------|----------------------|------------------|------------------|------------------|----------------------|
| 021-1137 | 021-1138 | 021-1139         | 021-1140   | 021-1141 | 021-1142             | 021-1143         | 021-1144         | 021-1145         | 021-1146             |
| #1       | #2       | #3<br>Extra-Flex | Micro-Mini | Mini 1   | Mini 4<br>Extra-Flex | #4<br>Extra-Flex | #5<br>Flexi-Thin | #6<br>Flexi-Thin | Mini 3<br>Extra-Flex |



**IMPLANTOLOGY**  
 Implantologie

**BLACK TITANIUM COLOUR COATED INSTRUMENTS**

**BURNISHERS**

**FREEDMAN BURNISHERS**



021-1156  
21B

021-1157  
27/29

021-1158  
2  
Ladmore

021-1159  
3  
Ladmore

021-1160  
Freedman  
"Duckhead"

021-1161  
Freedman  
Small Contact  
Forming

021-1162  
Freedman  
Large Contact  
Forming

021-1163  
Small/  
Medium Ball  
Burnisher



**IMPLANTOLOGY**  
 Implantologie

**BLACK TITANIUM COLOUR COATED INSTRUMENTS**

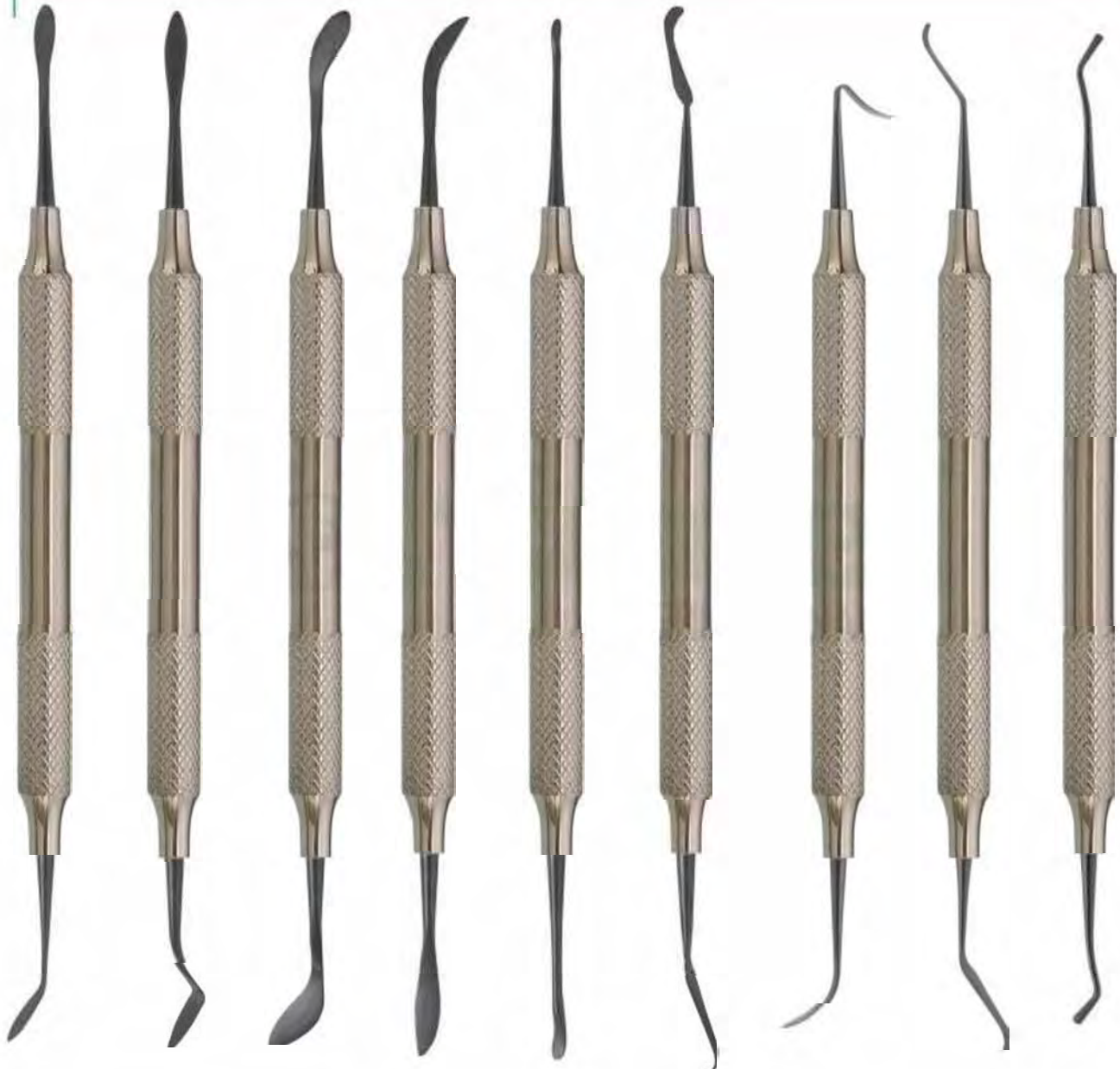

021-1164

A  
Cosmetic  
Contouring

021-1165

B  
Cosmetic  
Contouring

021-1166

C  
Cosmetic  
Contouring

021-1167

D  
Cosmetic  
Contouring

021-1168

E  
Cosmetic  
Contouring

021-1169

F  
Cosmetic  
Contouring

021-1170

Marginal Ridge  
& Embrasure  
Shaping Instrument

021-1171

Occlusal  
Anatomy  
Instrument

021-1172

Composite  
Packing  
Instrument



**IMPLANTOLOGY**  
 Implantologie

**BLACK TITANIUM COLOUR COATED INSTRUMENTS**

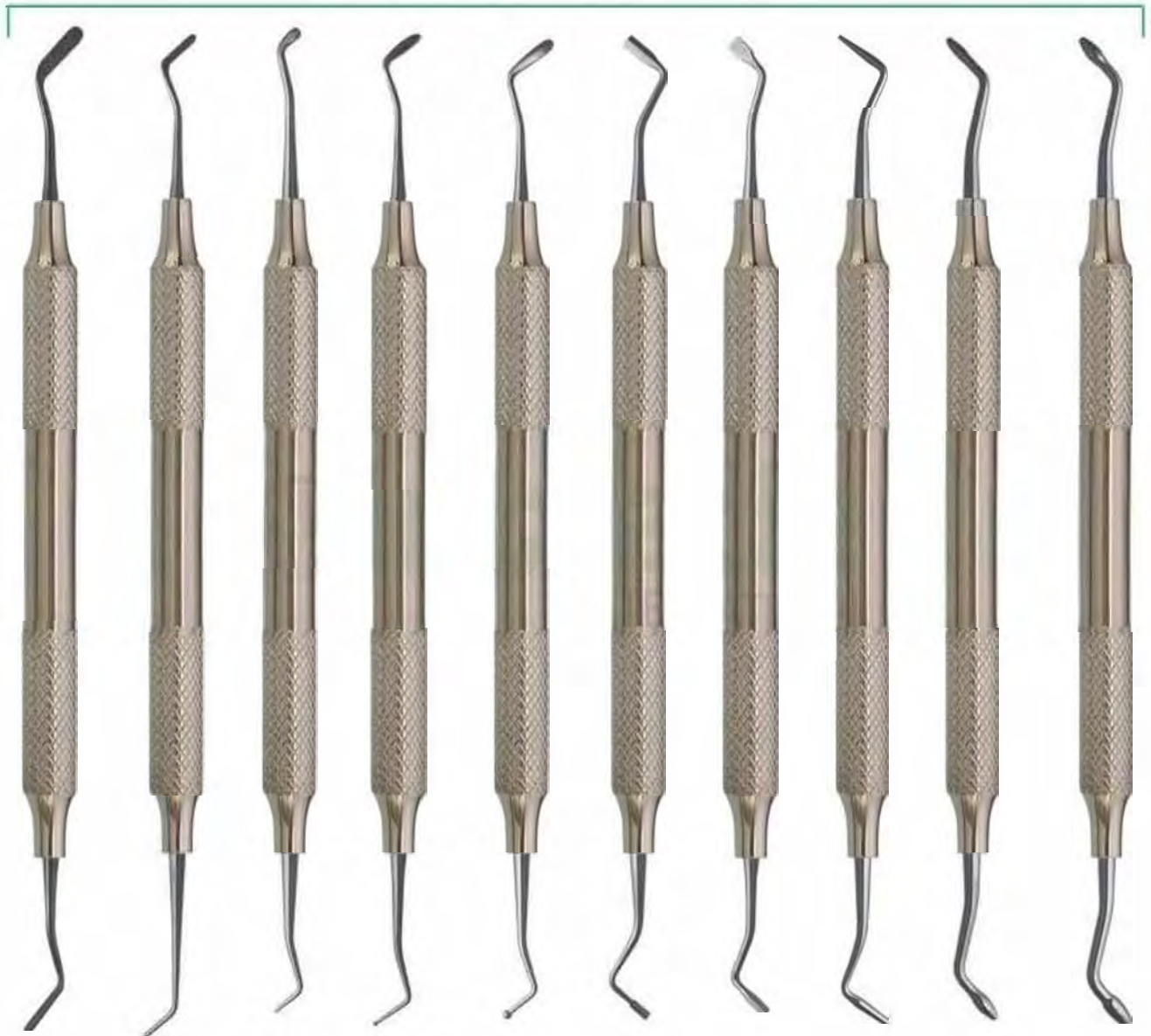

021-1173

#3  
Extra-Flex

021-1174

Mini 1

021-1175

Micro-Mini

021-1176

Medium  
Placing/  
Condensing

021-1177

Large  
Placing/  
Condensing

021-1178

OT  
Tanner

021-1179

3  
Hollenback

021-1180

5A

021-1181

Small/Medium  
Contact  
Forming

021-1182

Medium/Large  
Contact  
Forming



**IMPLANTOLOGY**  
 Implantologie

SINUS LIFT INSTRUMENTS HOLLOW HANDLE 9.5MM LENGTH 170MM

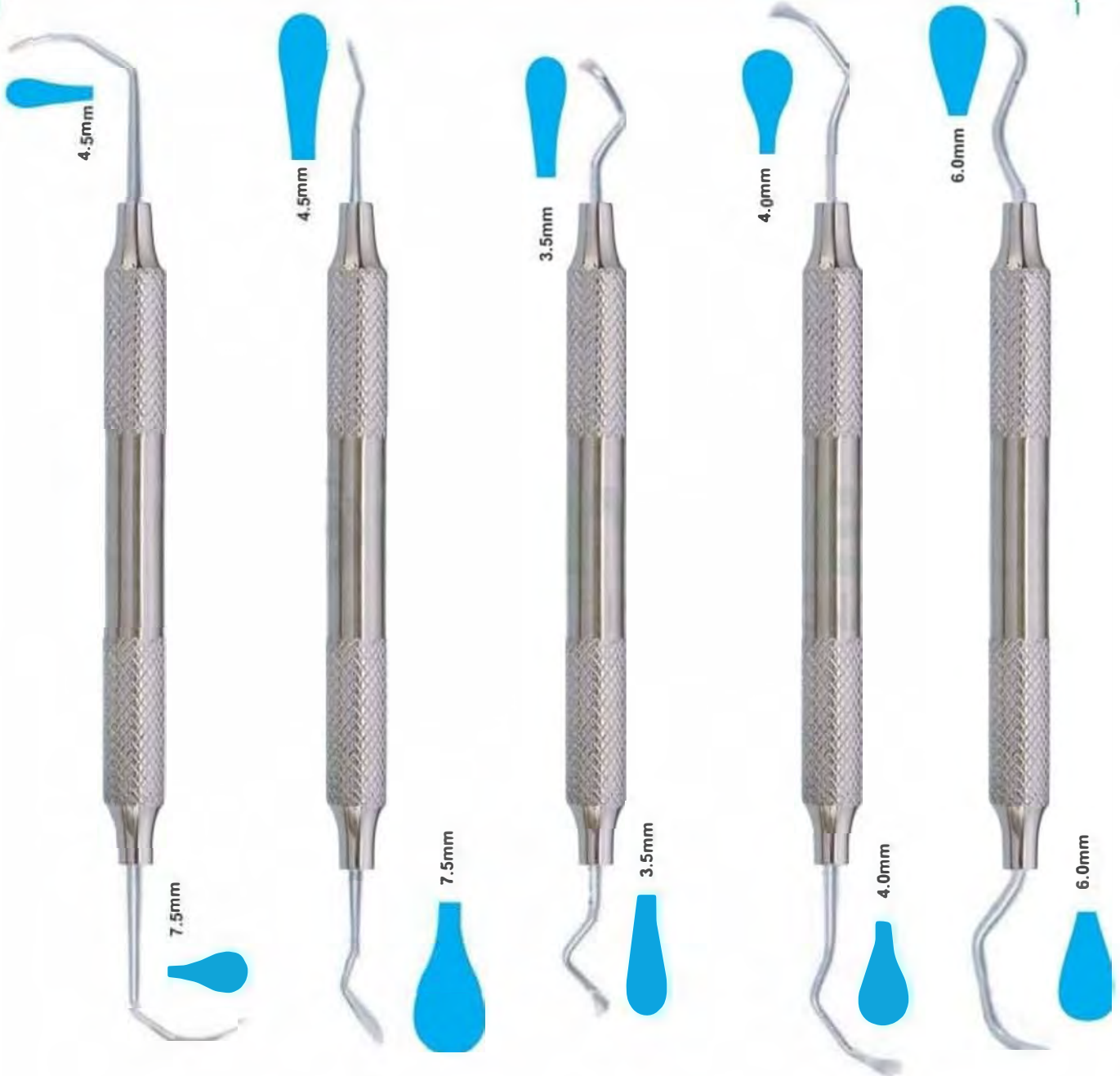

021-1183  
 Sinus Lift Elevator

021-1184  
 Sinus Lift Elevator

021-1185  
 Sinus Lift Elevator

021-1186  
 Sinus Lift Elevator

021-1187  
 Sinus Lift Elevator





**IMPLANTOLOGY**  
 Implantologie

SINUS LIFT INSTRUMENTS HOLLOW HANDLE 9.5MM LENGTH 170MM

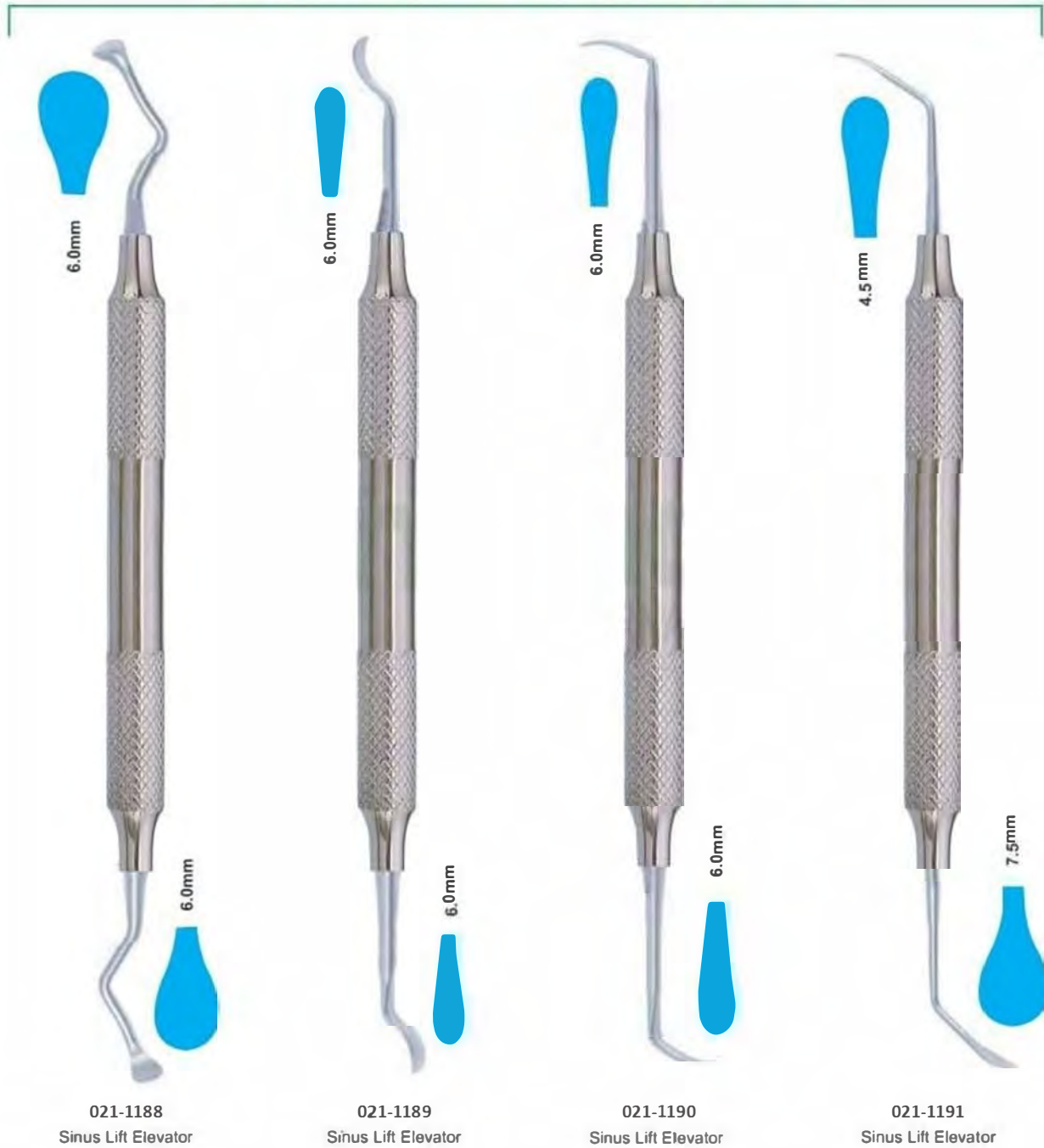



**IMPLANTOLOGY**  
 Implantologie

**IMPLANT SINUS LIFT INSTRUMENTS HOLLOW HANDLE 9.5MM LENGTH 170MM**



021-1192

021-1193

021-1194

021-1195

021-1196

021-1197

021-1198

021-1199

Acute 6577

Sinus1

Sinus2

Sinus3,  
Obtuse 6578

Sinus4

Sinus5

Sinus6

Sinus7



**IMPLANTOLOGY**  
 Implantologie

SINUS LIFT INSTRUMENTS HOLLOW HANDLE 9.5MM LENGTH 170MM

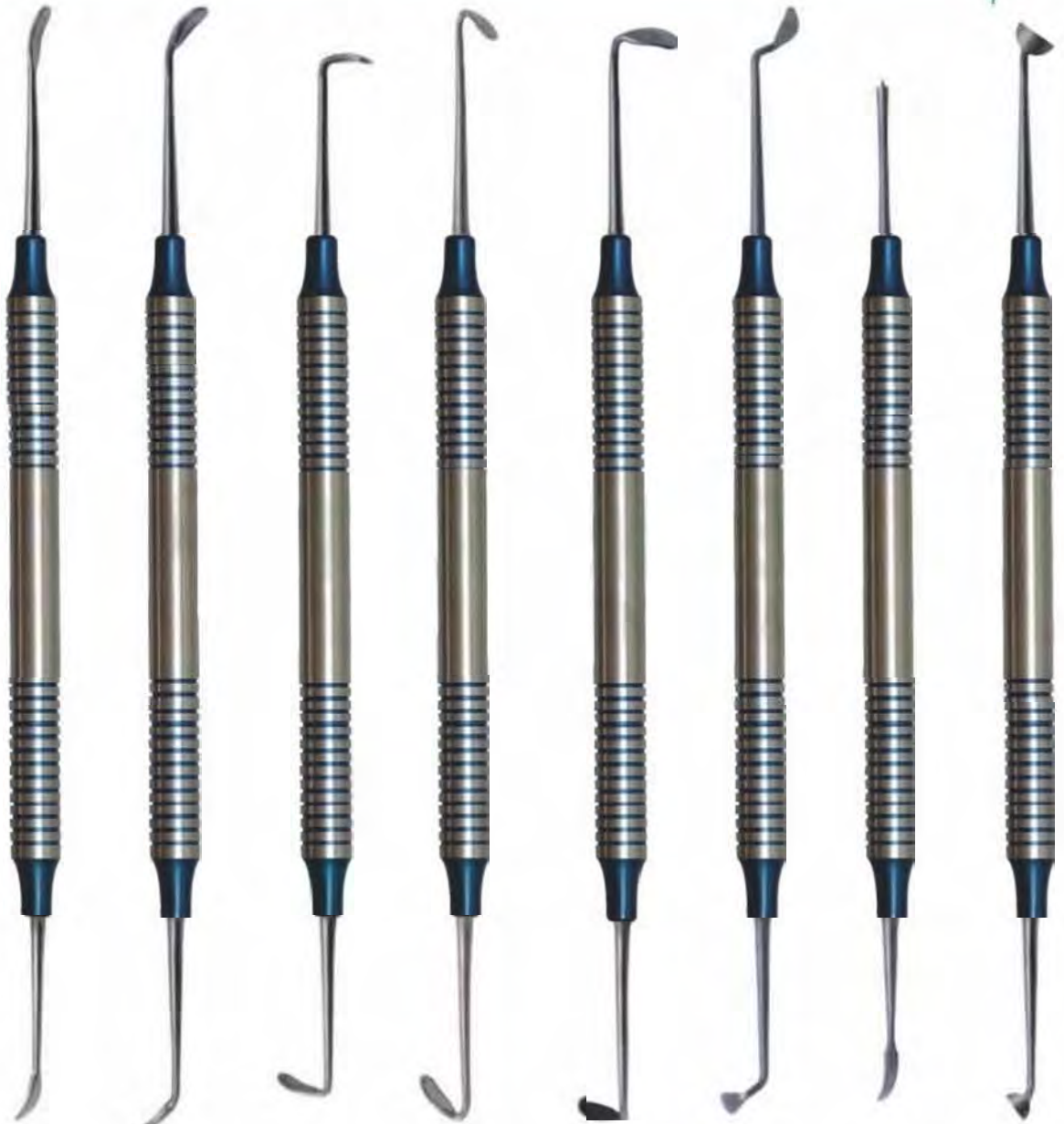

021-1200  
 Sinuslift 1

021-1201  
 Sinuslift 2

021-1202  
 Sinuslift 3

021-1203  
 Sinuslift 4

021-1204  
 Sinuslift 5

021-1205  
 Sinuslift 6

021-1206  
 Membrane  
 3Positioning 1

021-1207  
 Condenser



**IMPLANTOLOGY**  
**Implantologie**

**Sinus Lift Instrument,**  
 Flexible Sinus Lift instruments  
 reduce the risk of perforation of the  
 "Schneider's membrane"



021-1208

021-1209

021-1210

Fig. 1

Fig. 2

Fig. 3

**Sinus Lift Elevator,**  
 10 mm Straight grip  
 Length 175 mm, Sinus lift elevators, dull,  
 for gentle peeling and lifting the  
 Schneider membrane



021-1211

021-1212

021-1213

Fig. 1

Fig. 2

Fig. 3

**Sinus lift instrument**  
 10 mm Straight grip Length 180 mm,  
 Buser (B1, B2, B3) raspatories,  
 quality medical stainless steel,  
 corrosion-resistant



021-1214

021-1215

021-1216

B01

B02

B03



**IMPLANTOLOGY**  
 Implantologie

Sinus lift instrument 10 mm Straight gnp Sinus lift elevators, blunt or sharply curved  
 (H01, H02, K03, K04, K78, K77)

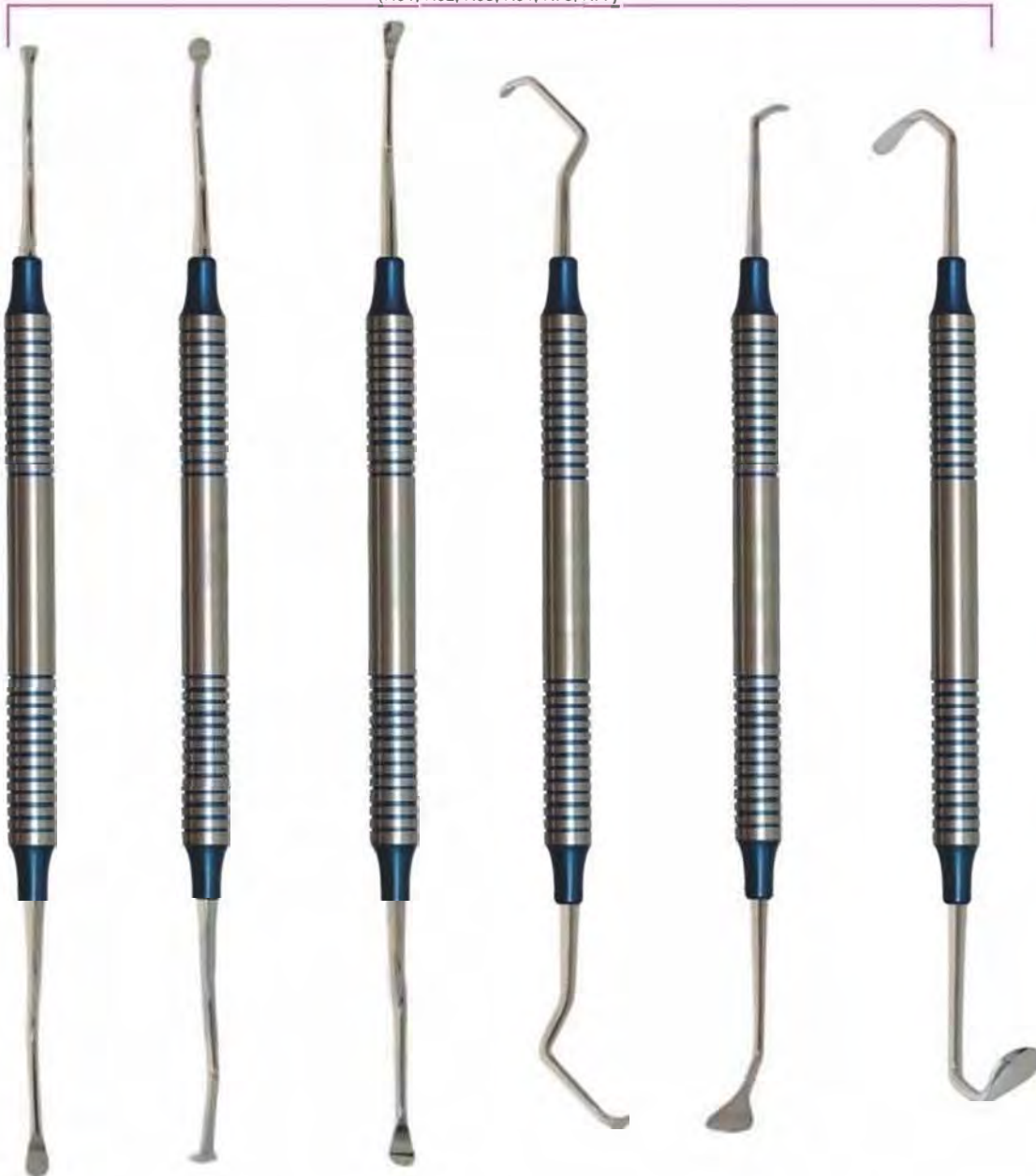

021-1217

Sinus lift  
 instrument  
 H01

021-1218

Sinus lift  
 instrument  
 H02

021-1219

Sinus lift  
 instrument  
 K03

021-1220

Sinus lift  
 instrument  
 K04

021-1221

Sinus lift  
 instrument  
 K78

021-1222

Sinus lift  
 instrument  
 K77



**IMPLANTOLOGY**  
 Implantologie

**SINUS LIFT INSTRUMENT**

Sinus Lift Elevators, 10 mm Hollow Handle length 170mm Blunt Curved Set of 6 Pcs



021-1223  
 Sinus lift  
 instrument

021-1224  
 Sinus lift  
 instrument

021-1225  
 Sinus lift  
 instrument

021-1226  
 Sinus lift  
 instrument

021-1227  
 Sinus lift  
 instrument

021-1228  
 Sinus lift  
 instrument



**IMPLANTOLOGY**  
 Implantologie

IMPLANT SINUS LIFT INSTRUMENTS  
 PERIODONTAL SURGERY SURGICAL CHISELS  
 KRAMER NEVINS SINUS LIFT



021-1229 TG



021-1230 SOLT3/4



021-1231 TGO



021-1232 29K



021-1233 FEDI4



021-1234 OCH3



021-1235 OCH4



021-1236 FEDI1



021-1237 FEDI2



021-1238 FEDI3



021-1239 Gf36



**IMPLANTOLOGY**  
 Implantologie

**IMPLANT**

**SURGICAL CHISELS**

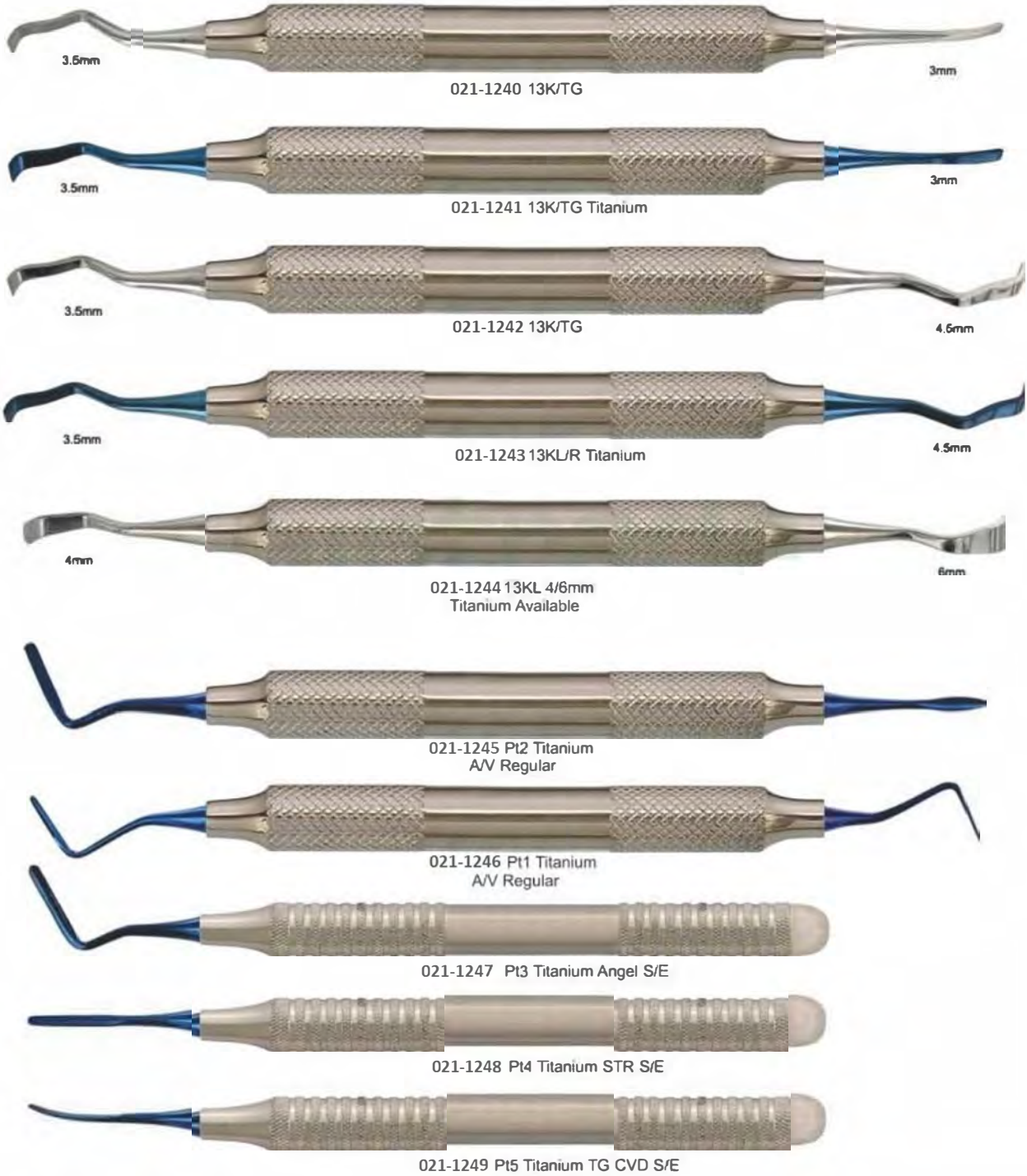





**IMPLANTOLOGY**  
 Implantologie

**MIXING SPATULA WITH SHOVEL**



021-1250  
 Bone Carrier  
 Titanium

021-1251  
**Raspator, Prichard**  
 Length 180 mm,  
 10 mm hollow handle,  
 double-ended  
 10.5 mm | 4.5 mm.

021-1252  
**Raspator, Prichard**  
 Length 180 mm,  
 10 mm hollow handle,  
 double ended

021-1253  
**Raspator, Prichard**  
 Length 180 mm,  
 10 mm hollow handle,  
 double-ended  
 10.5 mm | 4.5 mm.

021-1254  
**Mixing Spatula**  
 with shovel  
 17cm

021-1255  
**Mixing Spatula**  
 with shovel  
 18.5cm



**IMPLANTOLOGY**  
 Implantologie

**BONE GRAFTING INSTRUMENTS COMPACTOR /TAMPERS**

Product offering includes instruments for harvesting, mixing and compacting bone Provides clinicians with the proper instrumentation for bone grafting procedures Weighted bone basin Prevents tipping and spilling of bone and other materials during mixing



021-1256

Graft Packer,  
 Concave Tips  
 DE 4/6mm

021-1257

Bone Spoon/  
 Packer DE 3mm

021-1258

Graft Packer,  
 Serrated Tips  
 DE 6/8mm

021-1259

Graft Packer,  
 Serrated Tips  
 DE 3/4mm

021-1260

Graft Packer,  
 Smooth Tips  
 DE 5/8mm

021-1261

Titanium graft packer/  
 placement site depth  
 gauge 3 3mm & 4 0mm  
 Diameter tips Marked

021-1262

Graft Material Spoon  
 Concave Tip For  
 Larger Grafts



**IMPLANTOLOGY**  
 Implantologie

**BONE GRAFTING INSTRUMENTS**



**021-1263**  
**Blade and pusher**  
 Length 180 mm,  
 for straight or angled,  
 blade: 15 x 5 mm,  
 pusher: 4 mm diameter  
 Straight



**021-1264**  
**Blade and pusher**  
 Length 180 mm,  
 for straight or angled,  
 blade: 15 x 5 mm,  
 pusher: 4 mm diameter  
 angular



**021-1265**  
**Spoon and pusher**  
 Length 180 mm,  
 for angled spoon:  
 10 x 5 mm. pusher:  
 diameter 3 mm



**021-1266**  
**Tunnellerungs  
 Instrument**  
 length 175 mm,



**021-1267**  
**Tunnellerungs  
 Instrument**  
 length 175 mm,  
 different designs



**021-1268**  
**Tamper**  
 Length 170 mm,  
 for bone material,  
 double-ended,  
 diameter 3.2 mm  
 (2-4-6-8-10) and diameter  
 2.5mm (2-4-6-8-10)





**IMPLANTOLOGY**  
 Implantologie

**Pluggers Clarizio**

Length 160 mm, with titanium tips for mixing and pouring of autologous, heterologous bone substitute material, diameter (3/4 or 6/8 mm)

**BONE GRAFTING INSTRUMENTS**



021-1269  
 Ø 4mm  
 Ø 5mm  
 Compactor  
 150mm



021-1270  
 Sinus Window  
 Bone Tampers  
 4 mm



021-1271  
 Sinus Window  
 Bone Tampers  
 7 mm



021-1272  
 6/8mm



021-1273  
 3/4mm



**IMPLANTOLOGY**  
 Implantologie

**SPOON AND PUSHER (TRINOVO)**

Trinovo handle, different workers, for bone material, high-grade medical stainless steel, corrosion-resistant

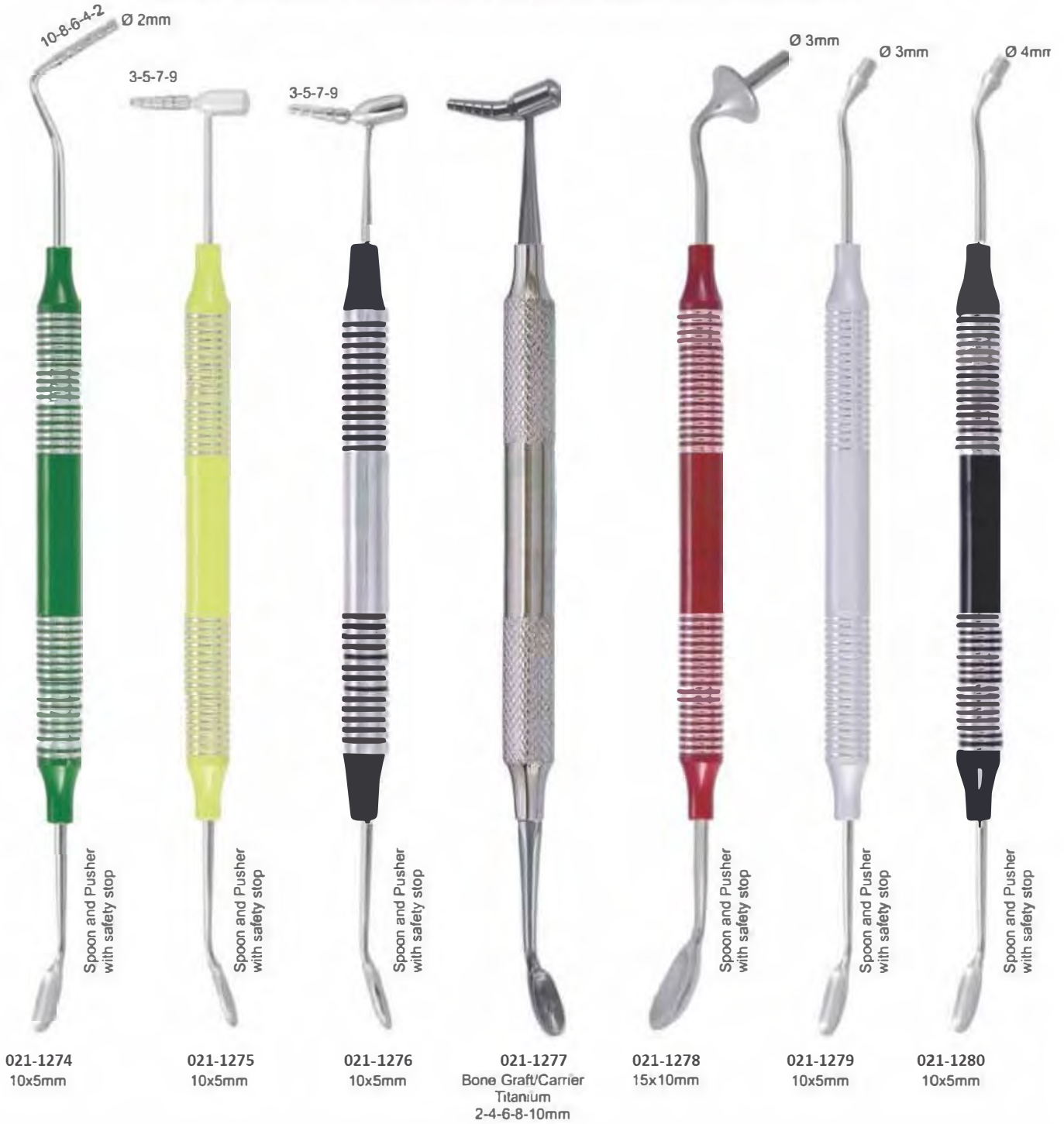



**IMPLANTOLOGY**  
 Implantologie

**PERIOSTEALS ELEVATOR 10mm Hollow Handle**



**021-1281**  
**Raspator, BonexScraper**  
 Length 165 mm, 10 mm hollow handle, double-ended 6 mm / 4 mm.

**021-1282**  
**Raspator, Raspatory**  
 Length 180 mm, 10 mm hollow handle, double-ended 3 mm | 3 mm,

**021-1283**  
**Raspator, Raspatory**  
 Length 180 mm, 10 mm hollow handle, double-ended 3 mm | 3 mm,

**021-1284**  
**Raspator, Papilla**  
 Length 185 mm, 10 mm hollow handle, double-ended 3 mm | 2 mm,

**021-1285**  
**Raspator, bone scraper**  
 Length 175 mm, 10 mm hollow handle, double-ended,

**021-1286**  
**Raspator, micro-Freer**  
 Length 180 mm, 6 mm solid gnp, double-ended 3 mm | 4 mm

**021-1287**  
**Raspator, Freer**  
 Length 180 mm, 6 mm solid handle, double-ended 5 mm | 5 mm,



**IMPLANTOLOGY**  
 Implantologie

**PERIOSTEALS ELEVATOR 10mm Hollow Handle**



**021-1288**  
**Raspator, Freer**  
 10 mm hollow handle, high-quality medical double ended

**021-1289**  
**Raspator, Molt**  
 Length 180 mm, 8 mm solid grip, double-ended 6 mm

**021-1290**  
**Raspator, micro Freer**  
 Length 185 mm, 10 mm hollow handle, double-ended,

**021-1291**  
**Raspator, micro Freer**  
 Length 185 mm, 10 mm hollow handle, double-ended,

**021-1292**  
**Raspator, micro Raspator / chisel**  
 Length 170 mm, 10 mm hollow handle, double-ended,

**021-1293**  
**Raspator, micro Raspator / chisel**  
 Length 175 mm, 10 mm hollow handle, double-ended,

**021-1294**  
**Raspator, Micro Raspator / chisel**  
 Length 175 mm, 8 mm solid handle, double-ended 3.5mm | 3.5 mm,



**IMPLANTOLOGY**  
 Implantologie

**PERIOSTEALS ELEVATOR 10mm Hollow Handle**



- |   |   |   |  |  |  |  |
|---|---|---|--|--|--|--|
| <p>021-1295<br/> <b>Raspatory Micro Molt</b><br/>                 Length 175 mm,<br/>                 corrosion-resistant</p> | <p>021-1296<br/> <b>Raspatory Chipping<br/>                 Workers:</b><br/>                 Chisel 24G and 7.5 mm,<br/>                 length about 175 mm,<br/>                 corrosion-resistant</p> | <p>021-1297<br/> <b>Raspatory MOLT</b><br/>                 Work ends:<br/>                 5.0 mm and 4.0 mm,<br/>                 length about 175 mm,<br/>                 corrosion-resistant</p> | <p>021-1298<br/> <b>Rasp, Molt M9</b><br/>                 Length 175 mm,<br/>                 corrosion-resistant</p> | <p>021-1299<br/> <b>Raspator, WAUTIER</b><br/>                 Length 175 mm,<br/>                 corrosion-resistant</p> | <p>021-1300<br/> <b>Raspator, BENQUE</b><br/>                 Length 170 mm,<br/>                 workers<br/>                 5 mm   7 mm,<br/>                 corrosion-resistant</p> | <p>021-1301<br/> <b>Raspator, Nordberg</b><br/>                 Length 180 mm,<br/>                 8 mm hollow handle,<br/>                 double-ended<br/>                 6 mm   4 mm</p> |
|---|---|---|--|--|--|--|





**IMPLANTOLOGY**  
 Implantologie

**PERIOSTEALS ELEVATOR 10mm Hollow Handle**



**021-1288**  
**Raspator, Freer**  
 10 mm hollow handle, high-quality medical double ended

**021-1289**  
**Raspator, Molt**  
 Length 180 mm, 8 mm solid grip, double-ended 6 mm

**021-1290**  
**Raspator, micro Freer**  
 Length 185 mm, 10 mm hollow handle, double-ended,

**021-1291**  
**Raspator, micro Freer**  
 Length 185 mm, 10 mm hollow handle, double-ended,

**021-1292**  
**Raspator, micro Raspator / chisel**  
 Length 170 mm, 10 mm hollow handle, double-ended,

**021-1293**  
**Raspator, micro Raspator / chisel**  
 Length 175 mm, 10 mm hollow handle, double-ended,

**021-1294**  
**Raspator, Micro Raspator / chisel**  
 Length 175 mm, 8 mm solid handle, double-ended 3.5mm | 3.5 mm,



**IMPLANTOLOGY**  
 Implantologie

**TISSUE MEMBRANE FORCEPS**



022-1311  
 Tissue Graft Forcep  
 Serrated Teeth



022-1312  
 Self Locking  
 Grooved



022-1313  
 Tissue Graft Forcep  
 Serrated Teeth



022-1314  
 Titanium  
 Locking Plier



022-1315  
 TC Gripper Carbide  
 Tipped Tissue Forceps  
 Serrated Carbide Tips  
 14.5cm



022-1316  
 Adson Carbide  
 Tipped Tissue Forceps  
 Serrated Carbide Tips  
 12cm



022-1317  
 Micor Adson 1x2  
 Tissue Forcep 12.1cm  
 1x2 Teeth - 0.5mm Tips



022-1318  
 Adson 7x7  
 Tissue Forceps  
 7x7 Teeth 12cm



022-1319  
 Adson 7x7 Curved  
 Tissue Forceps  
 7x7 Teeth 12cm



022-1320  
 Suture Pliers  
 Suture Forceps with  
 1.6mm Ring Tip



022-1321  
 Debakey Atraumatic  
 Tissue Forceps Straight  
 Serrated Teeth  
 16cm



022-1322  
 Debakey Atraumatic  
 Tissue Forceps Curved  
 Serrated Teeth  
 16cm



**IMPLANTOLOGY**  
 Implantologie

**TISSUE MEMBRANE FORCEPS**



022-1323  
 Russian Long  
 Tissue Forceps  
 Serrated Tip  
 20cm



022-1324  
 Russian  
 Tissue Forceps  
 Serrated Tip  
 15cm



022-1325  
 Tissue Punch Forceps  
 To Remove Tissue  
 After Using Punch



022-1326  
 13.5 cm  
 narrow



022-1327  
 10.5 cm  
**Membrane tweezers KUEHNE**



022-1328  
 13.5 cm  
 wide



022-1329  
**Pin-Tweezers**  
 with or without lock,  
 length 15 cm,  
 with lock



022-1330  
 without lock,



022-1331  
**Haltepinzette with lock**  
 15,5 cm, for pins, towards  
 the tips, etc.,



022-1332  
 Carry Forceps  
 15cm



022-1333  
 Carry Forceps  
 15cm



022-1334  
 Carry Forceps  
 15cm



**IMPLANTOLOGY**  
 Implantologie

**OSTEOTOME CONVEXES / CONCAVE / CONIQUES**

CONVEXES



023-1335

SET OF 5 PIECES

CONCAVES



023-1336

SET OF 5 PIECES



CONIQUES



023-1337

SET OF 5 PIECES

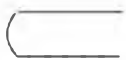



|   |                   |          |         |         |         |         |       |
|---|-------------------|----------|---------|---------|---------|---------|-------|
|  | CONVEXES STRAIGHT | 023-1338 | 2,7 Ømm | 3,2 Ømm | 3,7 Ømm | 4,2 Ømm | 5 Ømm |
|  | CONCAVES STRAIGHT | 023-1339 | 2,7 Ømm | 3,2 Ømm | 3,7 Ømm | 4,2 Ømm | 5 Ømm |
|  | CONIQUES STRAIGHT | 023-1340 | 2,7 Ømm | 3,2 Ømm | 3,7 Ømm | 4,2 Ømm | 5 Ømm |



**IMPLANTOLOGY**  
 Implantologie

**OSTEOTOME CONVEXES / CONCAVE / CONIQUES**



|   |                 |          |         |         |         |         |       |
|---|-----------------|----------|---------|---------|---------|---------|-------|
|  | CONVEXES CURVED | 023-1344 | 2,7 Ømm | 3,2 Ømm | 3,7 Ømm | 4,2 Ømm | 5 Ømm |
|  | CONCAVES CURVED | 023-1345 | 2,7 Ømm | 3,2 Ømm | 3,7 Ømm | 4,2 Ømm | 5 Ømm |
|  | CONIQUES CURVED | 023-1346 | 2,7 Ømm | 3,2 Ømm | 3,7 Ømm | 4,2 Ømm | 5 Ømm |



**IMPLANTOLOGY**  
 Implantologie

**BONE SCRAPER STRAIGHT & CURVED**



024-1347  
 Bone Scraper  
 Straight

024-1348  
 Bone Scraper  
 Curved

**TISSUE PUNCH STRAIGHT & CURVED**



024-1349  
 Tissue Punch  
 Straight



024-1356  
 Tissue Punch  
 Curved

- |                   |                   |
|-------------------|-------------------|
| ●                 | ●                 |
| 024-1350<br>2.0mm | 024-1351<br>4.0mm |
| ●                 | ●                 |
| 024-1352<br>5.0mm | 024-1353<br>6.0mm |
| ●                 | ●                 |
| 024-1354<br>7.0mm | 024-1355<br>8.0mm |

- |                   |                   |
|-------------------|-------------------|
| ●                 | ●                 |
| 024-1357<br>2.0mm | 024-1358<br>4.0mm |
| ●                 | ●                 |
| 024-1359<br>5.0mm | 024-1460<br>6.0mm |
| ●                 | ●                 |
| 024-1461<br>7.0mm | 024-1462<br>8.0mm |



024-1463  
 Bone Mill



024-1464  
 Basins For Bone



024-1465  
 BONE CRUSHER



**IMPLANTOLOGY**  
 Implantologie

**BONE INJECTORS, COLLECTORS & SUCTION TUBE**

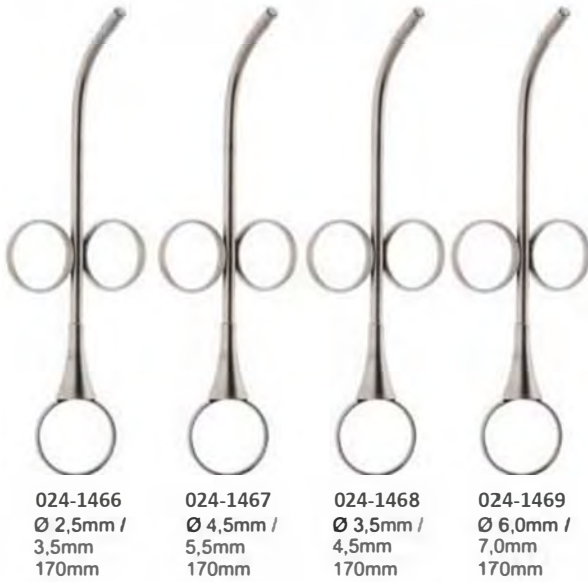

024-1466  
 Ø 2,5mm / 3,5mm / 170mm

024-1467  
 Ø 4,5mm / 5,5mm / 170mm

024-1468  
 Ø 3,5mm / 4,5mm / 170mm

024-1469  
 Ø 6,0mm / 7,0mm / 170mm

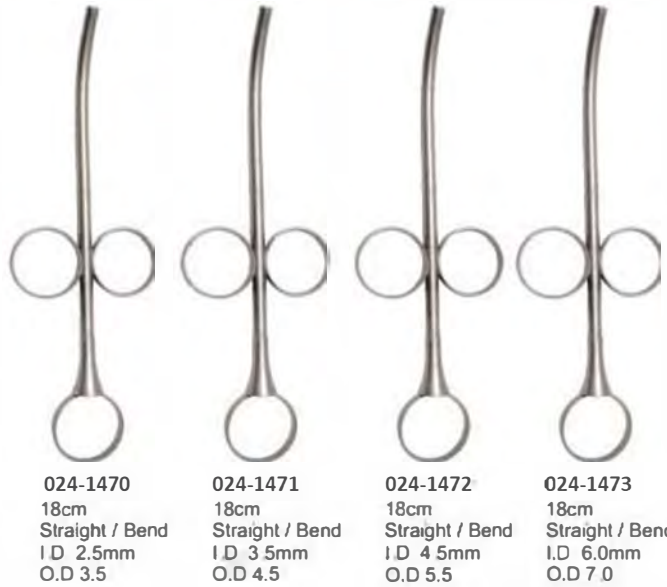

024-1470  
 18cm  
 Straight / Bend  
 I.D 2.5mm  
 O.D 3.5

024-1471  
 18cm  
 Straight / Bend  
 I.D 3.5mm  
 O.D 4.5

024-1472  
 18cm  
 Straight / Bend  
 I.D 4.5mm  
 O.D 5.5

024-1473  
 18cm  
 Straight / Bend  
 I.D 6.0mm  
 O.D 7.0



024-1474  
 17.5cm

024-1475  
 18cm

024-1476  
 coarse  
 Ø 5mm

024-1477  
 fine  
 Ø 9mm

Suction tubes to collect the extracted bone material 180mm



024-1478  
 Suction Tubes  
 180mm

024-1479  
 Suction Tubes  
 180mm

024-1480  
 Suction Tubes  
 180mm



024-1482  
 Ø 3 mm  
 length 180mm

024-1483  
 Ø 4 mm  
 length 180mm

024-1484  
 Ø 5 mm  
 length 180mm

024-1481  
 Fig. 6FR  
 Frazier  
 15 cm - Ø 2 mm



**IMPRESSION TRAYS**  
**PORTE EMPREINTE**

**PERFORATED WITH RIM LOCK**  
 Set of 06 Pcs



L 025-1485



M 025-1486



S 025-1487



L 025-1488



M 025-1489



S 025-1490

025-1489A **SET OF 06 PCS**  
 Upper: S, M, L  
 Lower: S, M, L

**PERFORATED WITH RIM LOCK**  
 Set of 8 Pcs



L 025-1491



M 025-1492



S 025-1493



XS 025-1494



L 025-1495



M 025-1496



S 025-1497



XS 025-1498

025-1499 **SET OF 08 PCS**  
 Upper: XS, S, M, L  
 Lower: XS, S, M, L

025-1500 **SET OF 08 PCS**  
 Upper: S, M, L, XL  
 Lower: S, M, L, XL

025-1501 **SET OF 10 PCS**  
 Upper: XS, S, M, L, XL  
 Lower: XS, S, M, L, XL





**IMPRESSION TRAYS**  
**PORTE EMPREINTE**

**SOLID WITH RIM LOCK**

Set of 6 Pcs



L 025-1502



M 025-1503



S 025-1504



L 025-1505



M 025-1506



S 025-1507

025-1508 **SET OF 06 PCS**

Upper: S, M, L  
 Lower: S, M, L

**SOLID WITH RIM LOCK**

Set of 8 Pcs



L 025-1509



M 025-1510



S 025-1511



XS 025-1512



L 025-1513



M 025-1514



S 025-1515



XS 025-1516

025-1517A **SET OF 08 PCS**  
 Upper: XS, S, M, L  
 Lower: XS, S, M, L

025-1518A **SET OF 08 PCS**  
 Upper: S, M, L, XL  
 Lower: S, M, L, XL

025-1519A **SET OF 10 PCS**  
 Upper: XS, S, M, L, XL  
 Lower: XS, S, M, L, XL



**INSTRUMENTS CASSETTES & STANDS**  
**Strumenti Vassoi cassettes**



Mesh Cassettes

- 026-1573 5 Pieces,
- 026-1573A 7 Pieces,
- 026-1573B 10 Pieces,
- 026-1573C 15 Pieces,
- 026-1573D 20 Pieces

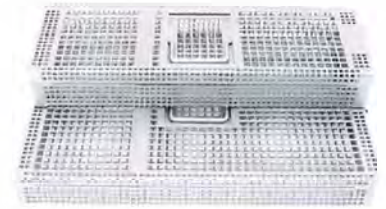

Instruments Cassette

- 026-1574 7 Pieces
- 026-1574A 10 Pieces



026-1575

Gracey Curette Set Cassettes



026-1576

- 182 x 150 x 20 mm
- 10 Instruments



026-1577

- 180 x 85 x 15 mm
- 5 Instruments



026-1578

- 288 x 182 x 35 mm
- 20 Instruments



026-1579

- 288 x 182 x 35 mm
- 20 Instruments



026-1580

- 182 x 145 x 35 mm
- 10 Instruments



026-1581

- 182 x 72 x 35 mm
- 5 Instruments



026-1582

- 182 x 145 x 35 mm
- 9 Instruments



026-1583

Gracey Curette Set Stand



026-1584

Sinus Lift Set Stand



**IMPRESSION TRAYS**  
**PORTE EMPREINTE**

Perforated Without Rim Lock



Solid With Rim Lock





**INSTRUMENTS CASSETTES & STANDS**  
**Strumenti Vassoi cassettes**

Sterilizing Cases  
Stainless Steel



|          |               |          |                |
|----------|---------------|----------|----------------|
| 026-1625 | 130X50X50 mm  | 026-1634 | 220X120X50 mm  |
| 026-1626 | 130X60X50 mm  | 026-1635 | 230X130X50 mm  |
| 026-1627 | 140X80X50 mm  | 026-1636 | 230X150X50 mm  |
| 026-1628 | 150X60X50 mm  | 026-1637 | 250X100X50 mm  |
| 026-1629 | 160X30X25 mm  | 026-1638 | 300X150X50 mm  |
| 026-1630 | 170X70X30 mm  | 026-1639 | 300X200X50 mm  |
| 026-1631 | 180X80X40 mm  | 026-1640 | 350X160X60 mm  |
| 026-1632 | 180X90X40 mm  | 026-1641 | 400X200X90 mm  |
| 026-1633 | 200X100X40 mm | 026-1642 | 500X200X125 mm |



|          |               |          |                |
|----------|---------------|----------|----------------|
| 026-1643 | 130X50X50 mm  | 026-1652 | 220X120X50 mm  |
| 026-1644 | 130X60X50 mm  | 026-1653 | 230X130X50 mm  |
| 026-1645 | 140X80X50 mm  | 026-1654 | 230X150X50 mm  |
| 026-1646 | 150X60X50 mm  | 026-1655 | 250X100X50 mm  |
| 026-1647 | 160X30X25 mm  | 026-1656 | 300X150X50 mm  |
| 026-1648 | 170X70X30 mm  | 026-1657 | 300X200X50 mm  |
| 026-1649 | 180X80X40 mm  | 026-1658 | 350X160X60 mm  |
| 026-1650 | 180X90X40 mm  | 026-1659 | 400X200X90 mm  |
| 026-1651 | 200X100X40 mm | 026-1660 | 500X200X125 mm |



**INSTRUMENTS BOX**

|          |               |          |                |
|----------|---------------|----------|----------------|
| 026-1661 | 130/50/50 mm  | 026-1671 | 230/130/50 mm  |
| 026-1662 | 130/60/50 mm  | 026-1672 | 230/150/50 mm  |
| 026-1663 | 140/80/50 mm  | 026-1673 | 250/150/50 mm  |
| 026-1664 | 150/60/50 mm  | 026-1674 | 300/150/50 mm  |
| 026-1665 | 160/30/25 mm  | 026-1675 | 300/200/50 mm  |
| 026-1666 | 170/70/30 mm  | 026-1676 | 350/160/60 mm  |
| 026-1667 | 180/80/40 mm  | 026-1677 | 350/160/60 mm  |
| 026-1668 | 180/90/40 mm  | 026-1678 | 400/200/90 mm  |
| 026-1669 | 200/100/40 mm | 026-1679 | 500/200/125 mm |
| 026-1670 | 220/120/50 mm |          |                |



**NEEDLES BOX**

|          |               |
|----------|---------------|
| 026-1680 | 150/60/20 mm  |
| 026-1681 | 140/80/20 mm  |
| 026-1682 | 220/120/20 mm |



**FORCEPS JAR**

|          |             |
|----------|-------------|
| 026-1683 | Fig. 1 to 5 |
| ∅        | h           |
| mm       | mm          |
| 52       | 100         |
| 52       | 130         |
| 52       | 175         |
| 70       | 130         |
|          | 175         |
|          | 200         |
|          | 200         |



|                     |          |
|---------------------|----------|
| <b>Forceps Jars</b> |          |
| 026-1684            | Fig. 3/3 |
| ∅                   | h        |
| mm                  | mm       |
| 25                  | 130      |



|                    |             |
|--------------------|-------------|
| <b>Forceps Jar</b> |             |
| 026-1685           | 25 x 80mm   |
| 026-1686           | 30 x 100mm  |
| 026-1687           | 100 x 200mm |
| 026-1688           | 75 x 173mm  |



**INSTRUMENTS CASSETTES & STANDS**  
**Strumenti Vassoi cassettes**

Made of 18/8 stainless steel



**KIDNEY TRAY WITH COVER**  
 (English Pattern)

|          | Size   |
|----------|--------|
| 026-1585 | 150 mm |
| 026-1586 | 200 mm |
| 026-1587 | 240 mm |
| 026-1588 | 300 mm |



**Kidney Trays**

| With lid available | Without lid available |
|--------------------|-----------------------|
| 026-1589 6"        | 026-1593 6"           |
| 026-1590 8"        | 026-1594 8"           |
| 026-1591 10"       | 026-1595 10"          |
| 026-1592 12"       | 026-1596 12"          |



| Deep                   |
|------------------------|
| 026-1597 2.25" - 2"    |
| 026-1598 4.75" - 2"    |
| 026-1599 5.5" - 2.5"   |
| 026-1600 6.25" - 2.75" |
| 026-1601 7" - 3.5"     |



**Sterilizing Drum**

| Art #    | Ø mm | h mm |
|----------|------|------|
| 026-1602 | 80   | 80   |
| 026-1603 | 120  | 120  |
| 026-1604 | 160  | 120  |
| 026-1605 | 190  | 140  |
| 026-1606 | 190  | 200  |
| 026-1607 | 240  | 120  |
| 026-1608 | 240  | 160  |
| 026-1609 | 240  | 240  |
| 026-1610 | 290  | 120  |
| 026-1611 | 290  | 160  |
| 026-1612 | 290  | 240  |
| 026-1613 | 340  | 160  |
| 026-1614 | 340  | 240  |
| 026-1615 | 390  | 145  |
| 026-1616 | 390  | 200  |
| 026-1617 | 390  | 290  |



**Bowl 026-1618**  
 Fig. 1 to 14



**026-1619**  
**Endodontic Box**



| Without Lid        |
|--------------------|
| 026-1620 6" x 8"   |
| 026-1621 8" x 10"  |
| 026-1622 10" x 12" |



**Instruments Box**  
 026-1623



**SCALER TRAY**  
 026-1624  
 100 x 200 mm



**INSTRUMENTS CASSETTES & STANDS**  
**Strumenti Vassoi cassettes**

Cotton waste receiver stainless steel



Mm Hmm  
 55 70  
**Cotton Holders**  
 026-1689 Fig. 000/1



026-1692  
 Sprit Lamp  
 Single Nut

Cotton dispensers stainless steel



026-1690

Cotton container stainless steel



026-1693

Cotton dispensers stainless steel



Cotton Holder -  
 026-1691



026-1694  
 Spirit Lamp

Instrument trays stainless steel



Fig. 1 026-1695  
 185 x 80 x 15 mm



Fig. 2 026-1696  
 190 x 100 x 17 mm



Fig. 3 026-1697  
 190 x 100 x 25 mm



026-1698  
 Cover for DZ.420.030  
 Copercchia per DZ.420.030



Fig. 4 026-1699  
 190 x 100 x 15 mm



Fig. 5 026-1700  
 190 x 135 x 15 mm



|          | A mm | B mm | C mm |
|----------|------|------|------|
| 026-1701 | 125  | 75   | 25   |
| 026-1702 | 150  | 120  | 30   |
| 026-1703 | 200  | 150  | 40   |
| 026-1704 | 250  | 200  | 50   |
| 026-1705 | 350  | 250  | 50   |
| 026-1706 | 455  | 350  | 50   |



Dental Instruments

Inquiry now Today!

 +92 342 8510373

 [info@shahbazsurgicalworks.com](mailto:info@shahbazsurgicalworks.com)

 [www.shahbazsurgicalworks.com](http://www.shahbazsurgicalworks.com)

